



# City of Belle Isle Job Site Card **ROOFING PERMIT** 2018-08-010

**PERMIT MUST BE POSTED ON SITE** - A permit expires in 6 months if approved inspections are not recorded /scheduled within that time frame. You are responsible for scheduling and keeping track of all your inspections -

Permit Number 2018-08-010

Issue Date: 08-10-2018

Site Address: 3519 Cullen Lake Shore Dr 32812

Parcel Number 17-23-30-438004180

Class: Residential

Sub-division:

Description of Work: **Re-roof 6100 SQFT Asphalt Shingles FOR MAIN HOUSE**

Issued To: Gold Key Roofing

Business Phone: 407 851-0680

Name: Hewitt, Jeffrey

Contractor License CCC1329157

Payment Date & Method: 8 / 13 / 2018  Picked up by \_\_\_\_\_

Visa  Master Card  Amex  Discover  Check / Money Order # 0767

Schedule Inspections via Email at: [BDscheduling@universalengineering.com](mailto:BDscheduling@universalengineering.com)

**SCHEDULE INSPECTIONS BY 3:00 PM CUT OFF TIME**

**Inspection Results Will Be Sent Out the Following Business Day**

**"WARNING TO OWNER: YOUR FAILURE TO RECORD A NOTICE OF COMMENCEMENT MAY RESULT IN YOUR PAYING TWICE FOR IMPROVEMENTS TO YOUR PROPERTY. IF YOU INTEND TO OBTAIN FINANCING, CONSULT WITH YOUR LENDER OR AN ATTORNEY BEFORE RECORDING YOUR NOTICE OF COMMENCEMENT."**

ROOF	INSPECTOR	DATE	COMMENTS
<b>NEW ROOFS ONLY</b> Code 700 Deck Nailing, Dry-In, Flashing			
<b>Both new &amp; re-roof</b> Code 710 In-Progress			
<b>Both new &amp; re-roof</b> Code 720 Final			

Inspection requests are to be emailed to [BDscheduling@UniversalEngineering.com](mailto:BDscheduling@UniversalEngineering.com); a confirmation email will be sent back to you upon scheduling. Next-Day Inspection requests must be made by 3:00 pm. Please include the following in your request: Permit #, project address, type of inspection, date of the requested inspection, a contact name & a contact phone number. AM or PM may be requested but cannot be guaranteed.



# City of Belle Isle

Universal Engineering Sciences 3532 Maggie Blvd., Orlando, FL 32811  
Tel 407-581-8161 \* Fax 407-581-0313 \* [www.universalengineering.com](http://www.universalengineering.com)

BY: \_\_\_\_\_

## APPLICATION FOR ROOFING PERMIT

WARNING TO OWNER: YOUR FAILURE TO RECORD A NOTICE OF COMMENCEMENT MAY RESULT IN YOUR PAYING TWICE FOR IMPROVEMENTS TO YOUR PROPERTY. A NOTICE OF COMMENCEMENT MUST BE RECORDED AND POSTED ON THE JOB SITE BEFORE THE FIRST INSPECTION. IF YOU INTEND TO OBTAIN FINANCING, CONSULT WITH YOUR LENDER OR AN ATTORNEY BEFORE RECORDING YOUR NOTICE OF COMMENCEMENT.

DATE OF APPLICATION: 8-3-18 ROOF PERMIT NUMBER: 2018-08-010

PLEASE PRINT. The undersigned hereby applies for a permit to make installations as indicated below:

Project Address: 3519 CULLEN LAKE SHORE DR, Belle Isle, FL 32809  32812

Property Owner: CHARLES WILLIAM GEORGE Phone: \_\_\_\_\_

Property Owner's Mailing Address: 3519 CULLEN LAKE SHORE DR City: ORLANDO

State: FL Zip Code: 32812 Parcel ID Number: 17-23-30-4380-04-180

REQUIRED! To obtain this information, please visit <http://www.ocnafi.org/Searches/ParcelSearch.aspx>

Class of Building: Old  New  Type of Building: Residential  Commercial  Other

Type of Work: New Roof  ReRoof  **FOR MAJW HOUSE**

- REQUIRED! Florida Product Approval Screen Printout from [www.floridabuilding.org](http://www.floridabuilding.org) showing the Code Version
- REQUIRED! Florida Product Approval Installation Instructions from [www.floridabuilding.org](http://www.floridabuilding.org) (not the manufacturer instructions)
- REQUIRED! Copies of your General Liability & Worker's Comp Insurance Certificate & State and Local Licenses

Please indicate the nature of work by completing the information below:

Roof Square Footage: 6100 SF Number of Stories: 2 Job Valuation: \$ 23,800 <sup>>15</sup>

Type: Asphalt Shingles  Metal  Modified Bitumen  Other: \_\_\_\_\_

I hereby certify that the above is true and correct to the best of my knowledge and make Application for Permit as outlined above, and if same is granted I agree to conform to all Florida Building Code Regulations and City Ordinances regulating same and in accordance with plans submitted. The issuance of this permit does not grant permission to violate any applicable Town and/or State of Florida codes and/or ordinances. By signing below, I recognize Republic Services is by legal contract the sole authorized provider of garbage, recycling, yard waste, and commercial garbage and construction debris collection and disposal services with the city limits of the City. Contractors, homeowners and commercial businesses may contact Republic Services at 407-293-8000 to setup accounts for Commercial Construction Roll Off, or other services needed. Rates are fixed by contract and are available at City Hall or from Republic Services. The City enforces the contract through its code enforcement office. Failure to comply will result in a stop work order.

LICENSE HOLDER SIGNATURE: [Signature] LICENSE # CCC1329157  
 LICENSE HOLDER NAME: JEFFREY HEWITT COMPANY NAME: GOLD KEY ROOFING  
 Street Address: 4874 S. ORANGE AVE  
 City: ORLANDO State: FL Zip Code: 32806 Phone Number: 407-851-0680  
 Email Address: JESSICA@GOLDKEYROOFING.COM

Zoning Fee	\$ 30.00
Permit Fee	\$ 140.00
Review Fee	\$ -
Florida Surcharge	\$ 4.10
Total Permit Fee	\$ 174.10

Building Official: SM Date: 8-6-2018

Verified Contractor's Licenses & Insurance are on file ✓ Date: 8-3-2018

MOON  
✓ POA  
The Building Permit Number is required if the Roof installation is associated with any construction or alteration where a Building Permit has been issued.

15% = 2.10  
 23x5 = 115  
 115 + 1.5% = 140  
 140 + 1.5% = 144.10  
 144.10 + 30.00 = 174.10

**PAID**  
8-13-18  
USA 0767

Permit Number: 2018-08-010  
 Folio/Parcel ID #: 17-23-30-4380-04-180  
 Prepared by: Gold Key  
4874 S Orange Ave  
Orlando, FL 32806  
 Return to: Gold Key  
4874 S Orange Ave  
Orlando, FL 32806

DOCH 20180421443  
 07/17/2018 11:34:35 AM Page 1 of 1  
 Rec Fee: \$10.00  
 Phil Diamond, Comptroller  
 Orange County, FL  
 MB - Ret To: GOLD KEY ROOFING



**NOTICE OF COMMENCEMENT**

State of Florida, County of Orange  
 The undersigned hereby gives notice that improvement will be made to certain real property, and in accordance with Chapter 713, Florida Statutes, the following information is provided in this Notice of Commencement.

- Description of property** (legal description of the property, and street address if available)  
LAKE CONWAY ESTATES SECTION TWO REPLAT X/150 LOT 18 BK D ... 3519 CULLEN LAKE SHORE DR
- General description of improvement**  
ReRoof
- Owner information or Lessee information if the Lessee contracted for the improvement**  
 Name CHARLES WILLIAM GEORGE  
 Address 3519 CULLEN LAKE SHORE DR  
 Interest in Property OWNER  
 Name and address of fee simple titleholder (if different from Owner listed above)  
 Name N/A  
 Address N/A
- Contractor**  
 Name Gold Key Roofing Telephone Number 407-851-0680  
 Address 4874 S Orange Ave Orlando, FL 32806
- Surety** (if applicable, a copy of the payment bond is attached)  
 Name N/A Telephone Number N/A  
 Address N/A Amount of Bond \$ N/A
- Lender**  
 Name N/A Telephone Number N/A  
 Address N/A
- Persons within the State of Florida designated by Owner upon whom notices or other documents may be served as provided by §713.13(1)(a)7, Florida Statutes.**  
 Name N/A Telephone Number N/A  
 Address N/A
- In addition to himself or herself, Owner designates the following to receive a copy of the Lienor's Notice as provided in §713.13(1)(b), Florida Statutes.**  
 Name N/A Telephone Number N/A  
 Address N/A
- Expiration date of notice of commencement** (the expiration date may not be before the completion of construction and final payment to the contractor, but will be 1 year from the date of recording unless a different date is specified) N/A

**WARNING TO OWNER: ANY PAYMENTS MADE BY THE OWNER AFTER THE EXPIRATION OF THE NOTICE OF COMMENCEMENT ARE CONSIDERED IMPROPER PAYMENTS UNDER CHAPTER 713, PART I, SECTION 713.13, FLORIDA STATUTES, AND CAN RESULT IN YOUR PAYING TWICE FOR IMPROVEMENTS TO YOUR PROPERTY. A NOTICE OF COMMENCEMENT MUST BE RECORDED AND POSTED ON THE JOB SITE BEFORE THE FIRST INSPECTION. IF YOU INTEND TO OBTAIN FINANCING, CONSULT WITH YOUR LENDER OR AN ATTORNEY BEFORE COMMENCING WORK OR RECORDING YOUR NOTICE OF COMMENCEMENT.**

\* Charles W. George, M.D. Owner  
 Signature of Owner or Lessee, or Owner's or Lessee's Authorized Officer/Director/Partner/Manager Signatory's Title/Office

The foregoing instrument was acknowledged before me this 6 day of 7/18 by CHARLES WILLIAM GEORGE  
 as himself for himself  
 Type of authority, e.g., officer, trustee, attorney in fact Name of party on behalf of whom instrument was executed  
James N. Graf JESSICA N GRAF  
 Signature of Notary Public - State of Florida Print, type, or stamp commissioned name of Notary Public

Personally Known OR Produced ID X  
 Type of ID Produced FL DL



## Susan Manchester

---

**From:** Jessica Graf <jessica@goldkeyroofing.com>  
**Sent:** Friday, August 10, 2018 12:25 PM  
**To:** Susan Manchester  
**Cc:** CobiPermits  
**Subject:** Re: 3519 Cullen Lake Shore Dr - House roof 2018-08-010 - dock needs separate app 2018-08-011 - Gold Key Roof

The dock is 5 SQ in the amount of \$2,850.00.  
The Main house is 61 SQ in the amount of \$23,800.00.

On Mon, Aug 6, 2018 at 8:32 AM, Susan Manchester <[SManchester@universalengineering.com](mailto:SManchester@universalengineering.com)> wrote:

Hi Jessica,

Please fill out a separate app for the boat dock roof. I will use a copy of the product approvals from the house and of course we have all the other paperwork. The one NOC is good for both projects – I do just need a separate app for dock. Please let me know how much I should (if any) adjust down the square footage on the main house permit of 5800 squares.

Thank you,

*Susan Manchester*

Permit Administration for the City of Belle Isle

Building Inspections and

Code Compliance Department

**E-mail:** [smanchester@universalengineering.com](mailto:smanchester@universalengineering.com)

**Website:** [www.universalengineering.com](http://www.universalengineering.com)



**UNIVERSAL ENGINEERING SCIENCES, INC.**  
3532 Maggie Blvd. | Orlando, FL 32811  
Tel: (407) 423-0504 | Fax: (407) 423-3106

**From:** Jessica Graf [mailto:[jessica@goldkeyroofing.com](mailto:jessica@goldkeyroofing.com)]  
**Sent:** Thursday, August 02, 2018 1:52 PM



# City of Belle Isle

Universal Engineering Sciences 3532 Maggie Blvd., Orlando, FL 32811  
 Tel 407-581-8161 \* Fax 407-581-0313 \* [www.universalengineering.com](http://www.universalengineering.com)

## Product Approval Form

DATE: \_\_\_\_\_

PERMIT # 2018-08-010

PROJECT ADDRESS 3519 CHILLEN LAKE SHORE DR

Belle Isle, FL  32809  32812

As required by Florida Statute 553.842 and Florida Administrative Code 9B-72m, please provide the information and approval numbers of the building components listed below if they will be utilized on the building or structure. FL Approved products are listed online at [www.floridabuilding.org](http://www.floridabuilding.org) or can be obtained from the local product supplier. The following information must be turned in with permit application and available onsite for inspections:

1. This Product Approval Cover Sheet
2. Internet screen from [FloridaBuilding.org](http://FloridaBuilding.org) showing PA#, approval and code edition stamped
3. Manufacturer's installation details from [FloridaBuilding.org](http://FloridaBuilding.org) and requirements for each product stamped

Product Type	Manufacturer	Model/Series	FL Product Approval #	Product Type	Manufacturer	Model/Series	FL Product Approval #
<b>EXTERIOR DOORS</b>				<b>WALL PANELS</b>			
Swinging				Sliding			
Sliding				Soffits			
Sectional/Rollup				Storefront			
Other				Glass Block			
				Other			
<b>WINDOWS</b>				<b>ROOFING PRODUCTS</b>			
Single/Dbf Hung				Asphalt Shingles	<b>CERTAINTED ASPHACT</b>	<b>FL5144-R13</b>	
Horizontal Slider				Non Struct Metal			
Casement				Roofing Tiles			
Fixed				Single Ply Roof			
Mullion				<b>UNDERLAYMENT</b>	<b>CERTAINTED ROOFUNDER</b>	<b>FL2184-R2</b>	
Skylights							
Other							
<b>STRUCTURAL COMPONENTS</b>				<b>OTHER</b>			
Wood Connectors							
Wood Anchors							
Truss Plates							
Insulation Forms							
Lintels							
Other							

It is the applicant's responsibility to verify that specific products have been installed in accordance with their limitations and with the minimum required design pressures for the structure. Specific compliance will be verified during field inspections.

Applicant Signature

Date 7/6/18



[BCIS Home](#)
[Log In](#)
[User Registration](#)
[Hot Topics](#)
[Submit Surcharge](#)
[Stats & Facts](#)
[Publications](#)
[FBC Staff](#)
[BCIS Site Map](#)
[Links](#)
[Search](#)



**Product Approval**  
USER: Public User

[Product Approval Menu](#) > 
 [Product or Application Search](#) > 
 [Application List](#) > 
 **Application Detail**

OFFICE OF THE SECRETARY

FL #	FL5444-R13								
Application Type	Revision								
Code Version	2017								
Application Status	Pending FBC Approval								
Comments	Archived								
Product Manufacturer	CertainTeed Corporation-Roofing								
Address/Phone/Email	20 Moores Road Malvern, PA 19355 (610) 893-5400 mark.d.harner@saint-gobain.com								
Authorized Signature	Mark Harner mark.d.harner@saint-gobain.com								
Technical Representative	Mark D. Harner								
Address/Phone/Email	18 Moores Road Malvern, PA 19355 (610) 651-5847 Mark.D.Harner@saint-gobain.com								
Quality Assurance Representative									
Address/Phone/Email									
Category	Roofing								
Subcategory	Asphalt Shingles								
Compliance Method	Evaluation Report from a Florida Registered Architect or a Licensed Florida Professional Engineer Evaluation Report - Hardcopy Received								
Florida Engineer or Architect Name who developed the Evaluation Report	Robert Nieminen								
Florida License	PE-59166								
Quality Assurance Entity	UL LLC								
Quality Assurance Contract Expiration Date	03/09/2020								
Validated By	John W. Knezevich, PE ✓ Validation Checklist - Hardcopy Received								
Certificate of Independence	<a href="#">FL5444_R13_COI_2018_01_COI_NIEMINEN.pdf</a>								
Referenced Standard and Year (of Standard)	<table border="0"> <thead> <tr> <th><b>Standard</b></th> <th><b>Year</b></th> </tr> </thead> <tbody> <tr> <td>ASTM D3161</td> <td>2016</td> </tr> <tr> <td>ASTM D3462</td> <td>2010</td> </tr> <tr> <td>ASTM D7158</td> <td>2011</td> </tr> </tbody> </table>	<b>Standard</b>	<b>Year</b>	ASTM D3161	2016	ASTM D3462	2010	ASTM D7158	2011
<b>Standard</b>	<b>Year</b>								
ASTM D3161	2016								
ASTM D3462	2010								
ASTM D7158	2011								
Equivalence of Product Standards Certified By									
Sections from the Code									

Product Approval Method Method 1 Option D

Date Submitted 01/24/2018  
 Date Validated 01/29/2018  
 Date Pending FBC Approval 01/30/2018

**Summary of Products**

FL #	Model, Number or Name	Description
5444.1	CertainTeed Asphalt Roof Shingles	3-tab, 4-tab, strip (no-cut-outs), laminated and architectural asphalt roof shingles
<b>Limits of Use</b> Approved for use in HVHZ: No Approved for use outside HVHZ: Yes Impact Resistant: N/A Design Pressure: N/A Other: Refer to ER Section 5 for Limits of Use		<b>Installation Instructions</b> <a href="#">FL5444 R13 II 2018 01 FINAL ER CERTAINTEED ASPHALT SHINGLES FL5444-R13.pdf</a> Verified By: Robert Nieminen, PE PE-59166 Created by Independent Third Party: Yes <b>Evaluation Reports</b> <a href="#">FL5444 R13 AE 2018 01 FINAL ER CERTAINTEED ASPHALT SHINGLES FL5444-R13.pdf</a> Created by Independent Third Party: Yes

[Back](#) [Next](#)

Contact Us :: [2601 Blair Stone Road, Tallahassee FL 32399](#) Phone: 850-487-1824

The State of Florida is an AA/EEO employer. [Copyright 2007-2013 State of Florida](#) :: [Privacy Statement](#) :: [Accessibility Statement](#) :: [Refund Statement](#)

Under Florida law, email addresses are public records. If you do not want your e-mail address released in response to a public-records request, do not send electronic mail to this entity. Instead, contact the office by phone or by traditional mail. If you have any questions, please contact 850.487.1395. \*Pursuant to Section 455.275(1), Florida Statutes, effective October 1, 2012, licensees licensed under Chapter 455, F.S. must provide the Department with an email address if they have one. The emails provided may be used for official communication with the licensee. However email addresses are public record. If you do not wish to supply a personal address, please provide the Department with an email address which can be made available to the public. To determine if you are a licensee under Chapter 455, F.S., please click [here](#).

Product Approval Accepts:



Credit Card  
**Safe**





**NEMO|etc.**

Certificate of Authorization #32455  
353 Christian Street, Unit #13  
Oxford, CT 06478  
(203) 262-9245

**ENGINEER**

**EVALUATE**

**TEST**

**CONSULT**

**CERTIFY**

**EVALUATION REPORT**

**CertainTeed Corporation**  
20 Moores Road  
Malvern, PA 19355  
**(610) 651-5847**

**Evaluation Report 3532.09.05-R14**  
**FL5444-R13**  
**Date of Issuance: 09/22/2005**  
**Revision 14: 01/24/2018**

**SCOPE:**

This Evaluation Report is issued under **Rule 61G20-3** and the applicable rules and regulations governing the use of construction materials in the State of Florida. The documentation submitted has been reviewed by Robert Nieminen, P.E. for use of the product under the Florida Building Code and Florida Building Code, Residential Volume. The products described herein have been evaluated for compliance with the **6<sup>th</sup> Edition (2017) Florida Building Code** sections noted herein.

**DESCRIPTION: CertainTeed Asphalt Roof Shingles.**

**LABELING:** Labeling shall be in accordance with the requirements of the Accredited Quality Assurance Agency noted herein and **FBC 1507.2.7.1 / R905.2.6.1**

**CONTINUED COMPLIANCE:** This Evaluation Report is valid until such time as the named product(s) changes, the referenced Quality Assurance documentation changes, or provisions of the Code that relate to the product change. Acceptance of this Evaluation Report by the named client constitutes agreement to notify Robert Nieminen, P.E. of any changes to the product(s), the Quality Assurance or the production facility location(s). NEMO|etc. requires a complete review of this Evaluation Report relative to updated Code requirements with each Code Cycle.

**ADVERTISEMENT:** The Evaluation Report number preceded by the words "NEMO|etc. Evaluated" may be displayed in advertising literature. If any portion of the Evaluation Report is displayed, then it shall be done in its entirety.

**INSPECTION:** Upon request, a copy of this entire Evaluation Report shall be provided to the user by the manufacturer or its distributors and shall be available for inspection at the job site at the request of the Building Official.

This Evaluation Report consists of pages 1 through 13.

**Prepared by:**

**Robert J.M. Nieminen, P.E.**  
*Florida Registration No. 59166, Florida DCA ANE1983*

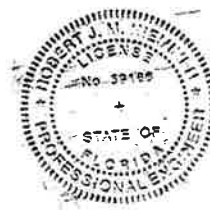

The facsimile seal appearing was authorized by Robert Nieminen, P.E. on 01/24/2018. This does not serve as an electronically signed document.

**CERTIFICATION OF INDEPENDENCE:**

1. NEMO|etc. does not have, nor does it intend to acquire or will it acquire, a financial interest in any company manufacturing or distributing products it evaluates.
2. NEMO|etc. is not owned, operated or controlled by any company manufacturing or distributing products it evaluates.
3. Robert Nieminen, P.E. does not have nor will acquire, a financial interest in any company manufacturing or distributing products for which the evaluation reports are being issued.
4. Robert Nieminen, P.E. does not have, nor will acquire, a financial interest in any other entity involved in the approval process of the product.
5. This is a building code evaluation. Neither NEMO|etc. nor Robert Nieminen, P.E. are, in any way, the Designer of Record for any project on which this Evaluation Report, or previous versions thereof, is/was used for permitting or design guidance unless retained specifically for that purpose.

**ROOFING SYSTEMS EVALUATION:**
**1. SCOPE:**

**Product Category:** Roofing  
**Sub-Category:** Asphalt Shingles

**Compliance Statement:** CertainTeed Asphalt Roof Shingles, as produced by CertainTeed Corporation, have demonstrated compliance with the following sections of the 6<sup>th</sup> Edition (2017) Florida Building Code and 6<sup>th</sup> Edition (2017) Florida Building Code, Residential Volume through testing in accordance with the following Standards. Compliance is subject to the Installation Requirements and Limitations / Conditions of Use set forth herein.

**2. STANDARDS:**

<u>Section</u>	<u>Property</u>	<u>Standard</u>	<u>Year</u>
1507.2.5, R905.2.4	Physical Properties	ASTM D3462	2010
1507.2.7.1, R905.2.6.1	Wind Resistance	ASTM D3161	2016
1507.2.7.1, R905.2.6.1	Wind Resistance	ASTM D7158	2011

**3. REFERENCES:**

<u>Entity</u>	<u>Examination</u>	<u>Reference</u>	<u>Date</u>
UL (TST 1740)	ASTM D3161	94NK9632	05/15/1998
UL (TST 1740)	ASTM D3161	99NK26506	11/23/1999
UL (TST 1740)	ASTM D3161	03CA12702	05/27/2003
UL (TST 1740)	ASTM D3161	03CA12702	06/16/2003
UL (TST 1740)	ASTM D3161	03NK29847	10/03/2003
UL (TST 1740)	ASTM D3161	04CA11329	05/24/2004
UL (TST 1740)	ASTM D3161	04CA32986	12/03/2004
UL (TST 1740)	ASTM D3161	05NK07049	04/15/2005
UL (TST 1740)	ASTM D3161	05NK16778	05/12/2005
UL (TST 1740)	ASTM D3161	05CA16778	05/12/2005
UL (TST 1740)	ASTM D3161	05NK14836	05/22/2005
UL (TST 1740)	ASTM D3161	05NK22800	06/22/2005
UL (TST 1740)	ASTM D3462	R684	09/21/2005
UL (TST 1740)	ASTM D7158	05NK08037	06/28/2006
UL (TST 1740)	ASTM D3161 & D3462	09CA28873	07/23/2009
UL (TST 1740)	ASTM D3462	10CA41303	10/07/2010
UL (TST 1740)	ASTM D3161	10CA41303	10/08/2010
UL (TST 1740)	ASTM D7158	10CA41303	10/27/2010
UL (TST 1740)	ASTM D3161 & D3462	10CA44960	11/11/2010
UL LLC (TST 9628)	ASTM D3161, D3462 & D7158	13CA32897	11/21/2013
UL LLC (TST 9628)	ASTM D3161, D3462	TFWZ.R684	04/22/2014
UL LLC (TST 9628)	ASTM D7158	TGAH.R684	04/22/2014
UL LLC (TST 9628)	ASTM D3161 & D3462	4786334434	09/16/2014
UL LLC (TST 9628)	ASTM D3161 & D3462	4786570826	02/12/2015
UL LLC (TST 9628)	ASTM D3161, D3462 & D7158	4786570717	12/16/2015
UL LLC (TST 9628)	ASTM D3161 & D3462	4787195678	02/09/2016
UL LLC (TST 9628)	ASTM D3161, D3462 & D7158	4787380356	10/26/2016
UL LLC (TST 9628)	ASTM D3462	4787380357	10/13/2016
UL LLC (TST 9628)	ASTM D7158	4787380357	11/08/2016
UL LLC (TST 9628)	ASTM D3161	4787380357	11/09/2016
UL LLC (TST 9628)	ASTM D3161, D3462 & D7158	4787586427	01/25/2017
UL LLC (TST 9628)	ASTM D3161 & D3462	4788042412	11/15/2017
UL LLC (QUA 9625)	Quality Control	Service Confirmation	Exp. 03/09/2020

#### 4. PRODUCT DESCRIPTION:

##### 4.1 Asphalt Shingles:

- 4.1.1 **CT20™, XT™ 25, XT™ 30 and XT™ 30 IR** are fiberglass reinforced, 3-tab asphalt roof shingles.
- 4.1.2 **Arcadia™, Belmont®, Belmont® IR, Carriage House Shangle®, Grand Manor Shangle®, Landmark™, Landmark™ IR, Landmark™ Pro, Landmark™ Premium, Landmark™ TL, Landmark™ Solaris and Landmark™ Solaris IR** are fiberglass reinforced, laminated asphalt roof shingles.
- 4.1.3 **NorthGate™** is a fiberglass reinforced, laminated, SBS modified bitumen roof shingle.
- 4.1.4 **Presidential Shake™, Presidential Shake™ IR, Presidential Shake TL™ and Presidential Solaris™** are fiberglass reinforced, architectural asphalt roof shingles.
- 4.1.5 **Hatteras™, Highland Slate™ and Highland Slate™ IR** are fiberglass reinforced, 4-tab asphalt roof shingles.
- 4.1.6 **Patriot™** is a fiberglass reinforced asphalt roof strip-shingle (with no cut-outs) providing a laminated appearance through an intermittent shadow line with contrasting blend drops for color definition.

##### 4.2 Hip & Ridge Shingles:

- 4.2.1 **Presidential Accessory, Accessory for Hatteras, Shangle Ridge™, Shadow Ridge™, Cedar Crest™, Cedar Crest™ IR, NorthGate Ridge and NorthGate Accessory** are fiberglass reinforced accessory shingles for hip and ridge installation.

##### 4.3 Accessory Starter Strips:

- 4.3.1 **SwiftStart® Starter Shingle** is a starter strip for asphalt roof shingles. Its overall size of 15-1/4" x 38-3/4" yields two (2) 7-5/8" x 38-3/4" starter pieces per shingle.
- 4.4 Any of the above listed shingles may be produced in AR (algae resistant) versions.

#### 5. LIMITATIONS:

- 5.1 This is a building code evaluation. Neither NEMO|etc. nor Robert Nieminen, P.E. are, in any way, the Designer of Record for any project on which this Evaluation Report, or previous versions thereof, is/was used for permitting or design guidance unless retained specifically for that purpose.
- 5.2 This Evaluation Report is not for use within FBC HVHZ jurisdictions.
- 5.3 Fire Classification is not part of this Evaluation Report; refer to current Approved Roofing Materials Directory for fire ratings of this product.
- 5.4 Wind Classification:
  - 5.4.1 All shingles noted herein are Classified in accordance with **FBC Tables 1507.2.7.1 and R905.2.6.1 to ASTM D3161, Class F and/or ASTM D7158, Class H**, indicating the shingles are acceptable for use in all wind zones up to  $V_{asd} = 150$  mph ( $V_{ult} = 194$  mph). Refer to Section 6 for installation requirements to meet this wind rating.
  - 5.4.2 **Presidential Accessory, Accessory for Hatteras, Shangle Ridge, Shadow Ridge, Cedar Crest, NorthGate Ridge and NorthGate Accessory hip & ridge shingles** have been evaluated in accordance with **ASTM D3161, Class F**. All except **NorthGate Ridge and NorthGate Accessory** require use of **BASF Sonolastic NP 1 adhesive or Henkel PL® Polyurethane Roof & Flashing Sealant**, applied as specified in manufacturer's application instructions, for use in wind zones up to  $V_{asd} = 150$  mph ( $V_{ult} = 194$  mph). Refer to Section 6 for installation requirements to meet this wind rating.
  - 5.4.3 **SwiftStart® Starter Shingle** has been evaluated in accordance with **ASTM D3161, Class F**. Refer to Section 6 for installation requirements to meet this wind rating.
  - 5.4.4 Classification by **ASTM D7158** applies to **exposure category B or C** and a **building height of 60 feet or less**. Calculations by a qualified design professional are required for conditions outside these limitations. Contact the shingle manufacturer for data specific to each shingle.



5.4.4.1 **Analysis in accordance with ASTM D7158** indicates the measured uplift resistance ( $R_T$ ) for the CertainTeed asphalt Roof shingles listed in Section 4.1 through 4.6 (*except Presidential Solaris™*) exceeds the calculated uplift force ( $F_T$ ) at a maximum design wind speed of  $V_{asd} = 150$  mph ( $V_{ult} = 194$  mph) for **residential buildings** located in **Exposure D conditions** with **no topographical variations (flat terrain)** having a **mean roof height less than or equal to 60 feet**. The shingles are permissible under Code for installation in these conditions using the installation procedures detailed in this Evaluation Report and CertainTeed minimum requirements, subject to minimum codified fastening requirements established within any local jurisdiction, which shall take precedence.

5.5 All products in the roof assembly shall have quality assurance audits in accordance with **FAC Rule 61G20-3**.

**6. INSTALLATION:**

6.1 Roof deck, slope, underlayment and fasteners shall comply with **FBC 1507.2 / R905.2** and the shingle manufacturer's minimum requirements.

6.1.1 Underlayment shall be acceptable to **CertainTeed Corporation** and shall hold current Florida Statewide Product Approval, or be Locally Approved per **Rule 61G20-3**, per **FBC Sections 1507.2.3, 1507.2.4 or R905.2.3**.

6.2 Installation of asphalt shingles shall comply with the **CertainTeed Corporation** current published instructions, using minimum four (4) nails per shingle in accordance with **FBC 1507.2.7 or Section R905.2.6** and the minimum requirements herein.

6.2.1 Fasteners shall be in accordance with manufacturer's published requirements, but not less than **FBC 1507.2.6 or R905.2.5**. Staples are not permitted.

6.2.2 Where the roof slope exceeds 21 units vertical in 12 units horizontal, use the "Steep Slope" directions.

6.3 CertainTeed asphalt shingles are acceptable for use in reroof (tear-off) or recover applications, subject to the limitations set forth in **FBC Section 1511 or R908** and CertainTeed published installation instructions.

**6.4 SWIFTSTART® STARTER SHINGLE:**

**Fastening: Use four nails, located as shown below**

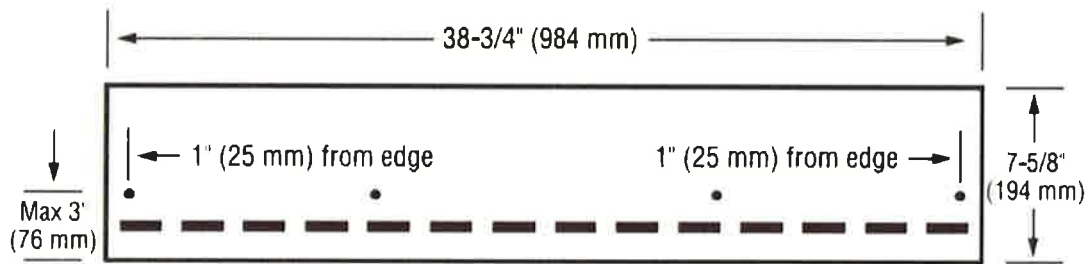

The inner two fasteners must be placed such that they fall at least 3" (76 mm) from the end joints of the shingle in the succeeding course.

**6.5 CT20™, XT™ 25, XT™ 30, XT™ 30 IR:**

**LOW AND STANDARD SLOPE**

**ENGLISH**

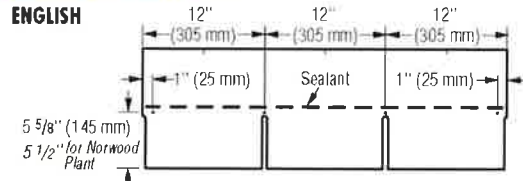

**METRIC**

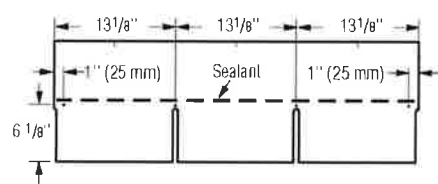
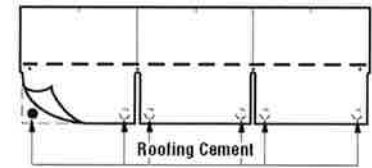

Figure 11-3: Use **four nails** for every full shingle.

**STEEP SLOPE**

Use **four nails** and six spots of asphalt roofing cement\* for every full shingle (Figure 11-4). Asphalt roofing cement meeting ASTM D4586 Type II is suggested.



Apply 1" (25 mm) spots of asphalt roofing cement under each tab corner.

Figure 11-4: Use **four nails** and six spots of asphalt cement on steep slopes.

**\*CAUTION:** Excessive use of roofing cement can cause shingles to blister.

**6.5.1 Hip & Ridge for CT20™, XT™ 25, XT™ 30, XT™ 30 IR: Cut Shingles**

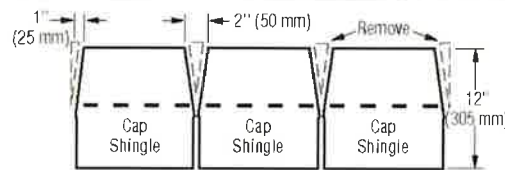

Figure 11-24: Cut tabs, then trim back to make cap shingles (English dimensions shown).

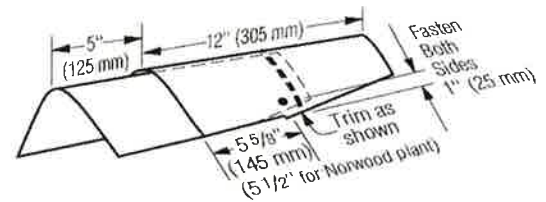

Figure 11-25: Installation of caps along the hips and ridges.

6.5.1.1 For ASTM D3161, Class F performance use BASF "Sonolastic® NP1™" adhesive or Henkel "PL® Polyurethane Roof & Flashing Sealant", in accordance with CertainTeed requirements.

**6.6 ARCADIA™:**

**LOW AND STANDARD SLOPE**

Use **SIX** nails for every full shingle located as shown below.

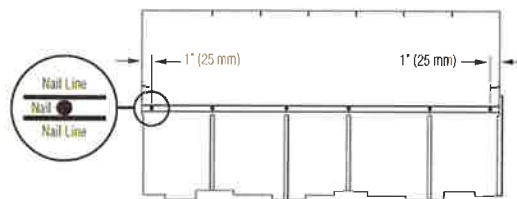

Figure 2: Use **six nails** for every full shingle.

**STEEP SLOPE**

Use **SIX** nails and **FOUR** spots of asphalt roofing cement for every full shingle as shown below. Apply asphalt roofing cement 1" (25 mm) from edge of shingle. Asphalt roofing cement meeting ASTM D 4586 Type II is suggested.

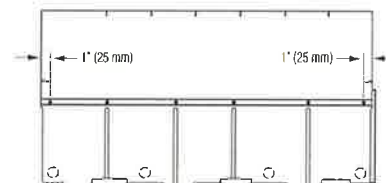
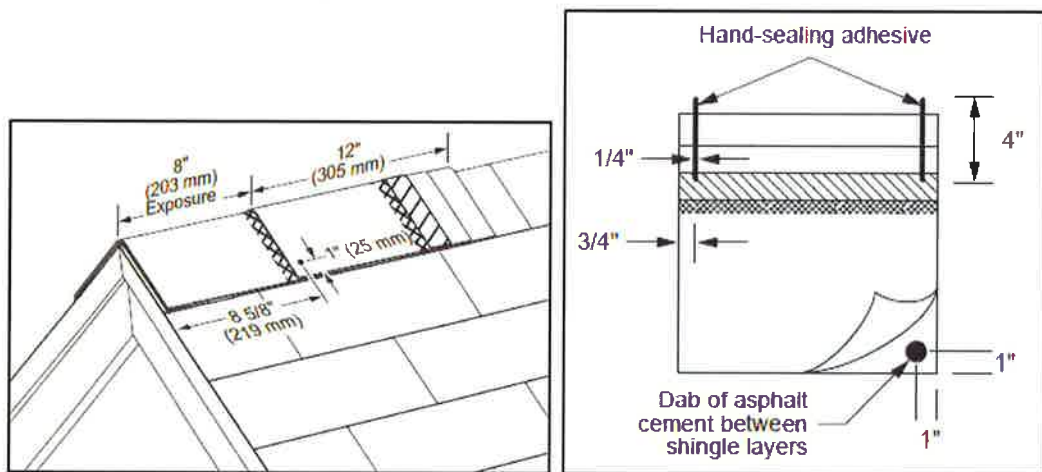

Figure 3: Use **six nails** and **four spots** of asphalt roofing cement on steep slopes.

6.6.1 **Hip & Ridge for Arcadia™: Cedar Crest™, Cedar Crest™ IR**

Use two (2), minimum 1¼-inch long fasteners per shingle. For the starter shingle, place fastener 1-inch from each side edge and about 2-inch up from the starter shingle's exposed butt edge, ensuring minimum ¾-inch embedment into the deck, or full penetration through the deck. For each full Cedar Crest shingle, place fasteners 8-5/8-inch up from its exposed butt edge and 1-inch from each side edge.

For ASTM D3161, Class F performance use BASF "Sonolastic® NP1™" adhesive or Henkel "PL® Polyurethane Roof & Flashing Sealant", in accordance with CertainTeed requirements, to **hand-seal Cedar Crest shingles**. Apply NP 1 or PL adhesive from the middle of the shingle's raised overlay on the top piece and extending approximately 4-inch along the sides of the headlap along a line ¾ to 1-inch from each side of the shingle's headlap. Immediately align and apply the overlying shingle, gently pressing tab sides into the adhesive, and install nails. To secure the other side, apply a 1-inch diameter spot of NP 1 or PL adhesive between the shingle layers.



6.7 **BELMONT® OR BELMONT® IR:**

**Low and Standard Slope (2:12 to 21:12):**

Use FIVE nails for every full Belmont shingle, located as shown below.

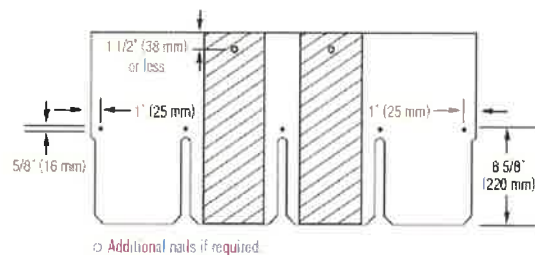

**Steep Slope (greater than 21:12):**

Use SEVEN nails and EIGHT spots of asphalt roofing cement\*\* for every full Belmont shingle. Apply asphalt roofing cement 1" (25mm) from edge of shingle. See below. Asphalt roofing cement meeting ASTM D4586 Type II is suggested.

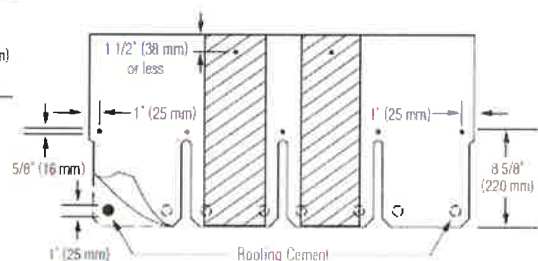

6.7.1 **Hip & Ridge for Belmont® or Belmont® IR:**

6.7.1.1 **Option 1:** For Belmont®, refer to instructions herein for Cedar Crest™ or Cedar Crest™ IR hip and ridge shingles. For Belmont® IR, refer to instructions herein for Cedar Crest™ IR hip and ridge shingles.

6.7.1.2 **Option 2:** For Belmont®: Shangle® Ridge

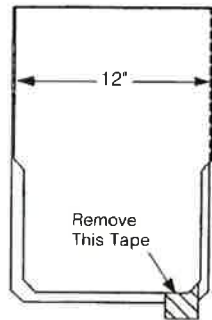

Figure 17-18: Shangle® Ridge.

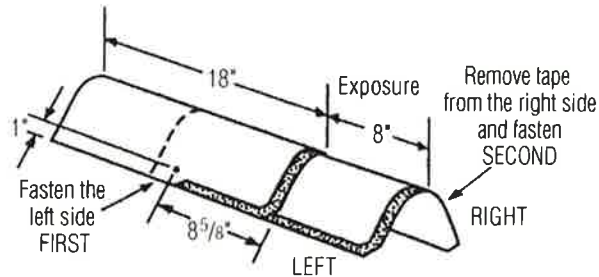

Figure 17-19: Installation of Shangle® Ridge shingles on hips and ridges.

6.7.1.3 For ASTM D3161, Class F performance use BASF “Sonolastic® NP1™” adhesive or Henkel “PL® Polyurethane Roof & Flashing Sealant”, in accordance with CertainTeed requirements.

**6.8 CARRIAGE HOUSE SHANGLE® AND GRAND MANOR SHANGLE®:**

**LOW AND STANDARD SLOPE**

Use five nails for every full Shangle.

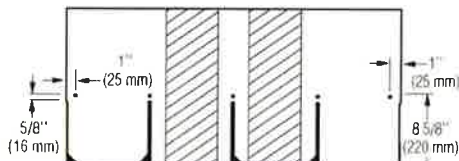

Figure 17-4: Use five nails for every full Grand Manor Shangle, Carriage House Shangle, or Centennial Slate.

**STEEP SLOPE**

Use seven nails and three spots of asphalt roofing cement for every full Grand Manor Shangle. Use five nails and three spots of asphalt roofing cement for every full Carriage House Shangle and Centennial Slate. Apply asphalt roofing cement 1” (25 mm) from edge of shingle (Figure 17-5). Asphalt roofing cement meeting ASTM D4586 Type II is suggested.

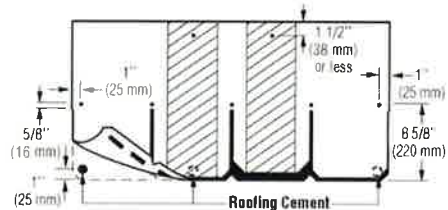

Figure 17-5: When installing Grand Manor Shingles on steep slopes, use seven nails and three spots of asphalt roofing cement.

6.8.1 **Hip & Ridge for Carriage House Shangle® and Grand Manor Shangle:** Refer to instructions herein for Shangle® Ridge hip and ridge shingles



6.9 LANDMARK™, LANDMARK™ IR, LANDMARK™ PRO, LANDMARK™ PREMIUM, LANDMARK™ TL, LANDMARK™ SOLARIS, LANDMARK™ SOLARIS IR, NORTHGATE:

LOW AND STANDARD SLOPE

LANDMARK TL

METRIC DIMENSIONS

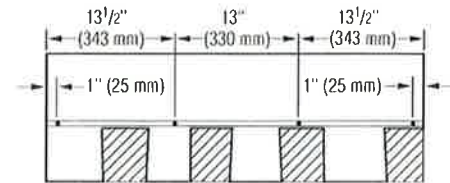
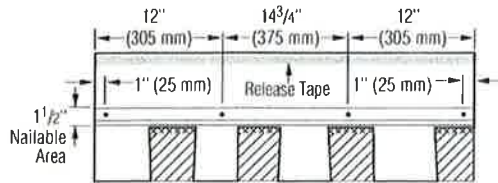
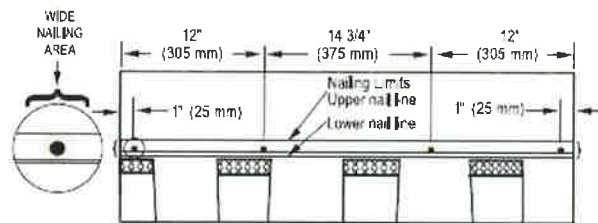

Figure 13-4: Use four nails for every full shingle.

NorthGate:



Nailing areas for low and standard slopes (from 2:12 to 21:12)  
Nail between upper & lower lines as shown above.

STEEP SLOPE

Use six nails and four spots of asphalt roofing cement for every full laminated shingle. See below. Asphalt roofing cement should meet ASTM D4586 Type II. Apply 1" spots of asphalt roofing cement under each corner and at about 12" to 13" in from each edge.

LANDMARK TL

METRIC DIMENSIONS

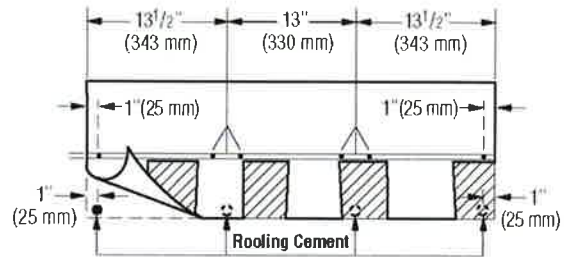
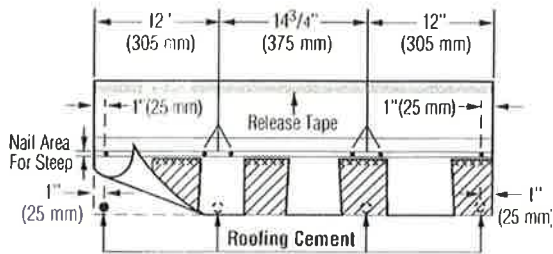
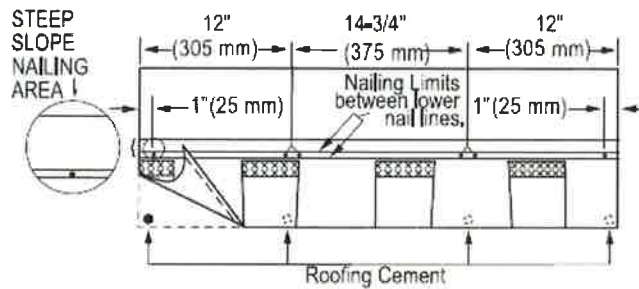

Figure 13-5: Use six nails and four spots of asphalt roofing cement on steep slopes.

**NorthGate:**



**Nailing areas for steep slopes (greater than 21:12) and "Storm-Nailing"**  
Nail between lower 2 nail lines as shown above.

6.9.1 **Hip & Ridge for Landmark™, Landmark™ IR, Landmark™ Pro, Landmark™ Premium, Landmark™ TL, Landmark™ Solaris, Landmark™ Solaris IR, NorthGate:**

6.9.1.1 **Option 1: Shadow Ridge™ or NothGate Accessory**

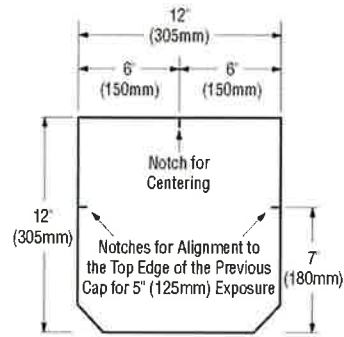

**English Dimension**

**Shadow Ridge™**

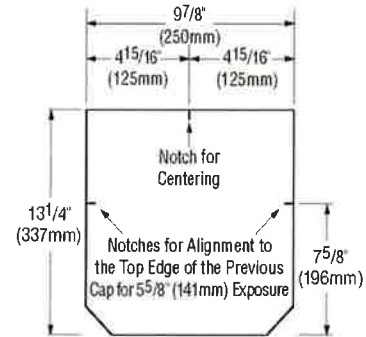

**Metric Dimension**

**Shadow Ridge™**

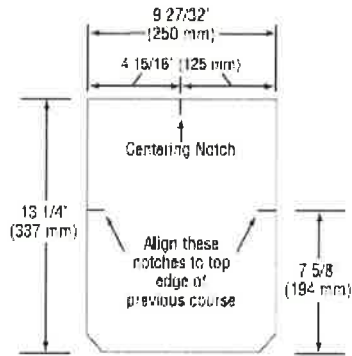

**NorthGate Ridge**

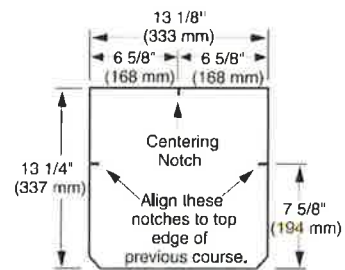

**NorthGate Accessory**

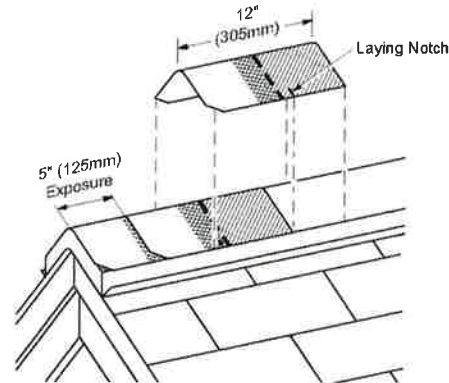

Figure 13-20: Use laying notches to center shingles on hips and ridges, and to locate the correct exposure.

- 6.9.1.2 For **ASTM D3161, Class F** performance use BASF “**Sonolastic® NP1™**” adhesive or Henkel “**PL® Polyurethane Roof & Flashing Sealant™**”, in accordance with CertainTeed requirements.
- 6.9.1.3 **Option 2:** Refer to instructions herein for **Cedar Crest™, Cedar Crest™ IR** hip and ridge shingles.

**6.10 PRESIDENTIAL SHAKE™, PRESIDENTIAL SHAKE™ IR, PRESIDENTIAL SHAKE TL™, PRESIDENTIAL SOLARIS™:**

**LOW AND STANDARD SLOPE:**

For low and standard slopes, use five nails for each full Presidential shingle as shown below.

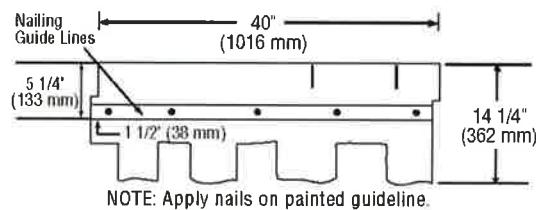

Figure 16-6: Fastening Presidential and Presidential TL Shake shingles on low and standard slopes.

**STEEP SLOPE:**

For steep slopes, use nine nails for each full Presidential shingle and apply 1" diameter spots of asphalt roofing cement under each shingle tab. After applying 5 nails in between the nailing guide lines, apply 4 nails 1" above tab cutouts making certain tabs of overlying shingle cover nails.

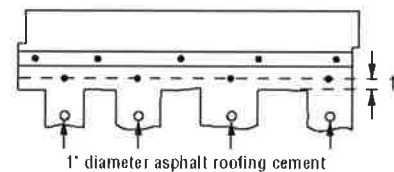

Figure 16-7: Fastening Presidential and Presidential TL Shake shingles on steep slopes.

**6.10.1 Hip & Ridge for Presidential Shake™, Presidential Shake™ IR, Presidential Shake TL™, Presidential Solaris™:**

**6.10.1.1 Option 1: Presidential Accessory**

**PRESIDENTIAL ACCESSORY**

Presidential accessory shingles can be used for covering hips and ridges. Apply shingles up to the ridge (expose no more than 7" from the bottom edge of the "tooth." Fasten each accessory with two fasteners. The fasteners must be 1 3/4" long or longer, so they penetrate either 3/4" into the deck or completely through the deck. Presidential accessory comes in two different sizes: Accessory produced in Birmingham, AL is 12" x 12"; Portland, OR produces 9 7/8" x 13 1/4" accessory.

- 6.10.1.2 For **ASTM D3161, Class F** performance use BASF “**Sonolastic® NP1™**” adhesive or Henkel “**PL® Polyurethane Roof & Flashing Sealant™**”, in accordance with CertainTeed requirements.

6.10.1.3 **Option 2:** Refer to instructions herein for Cedar Crest™, Cedar Crest™ IR hip and ridge shingles.

**6.11 HATTERAS™:**

**LOW, STANDARD AND STEEP SLOPE:**

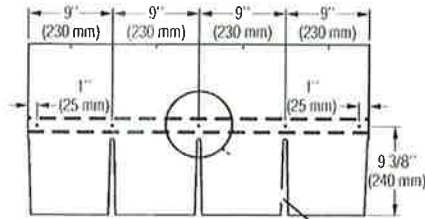

Figure 15-3: Fastening Hatteras Shingles on Low and Standard Slopes

For low and standard slopes, use five nails for each full Hatteras shingle as shown above.

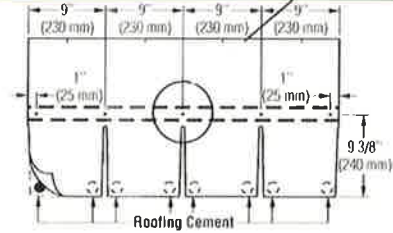

Figure 15-1: Fastening Hatteras Shingles on Steep Slopes

For steep slopes, use five nails and eight spots of asphalt roofing cement for each full Hatteras shingle as shown above. Apply 1" (25mm) diameter spots of roofing cement (ASTM D-4586 Type II suggested) under each tab corner. Press shingle into place; do not expose cement.

**CAUTION:** Too much roofing cement can cause shingles to blister.

**6.11.1 Hip & Ridge for Hatteras™:**

**6.11.1.1 Option 1:** Accessory for Hatteras

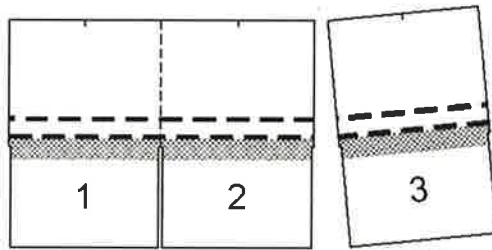
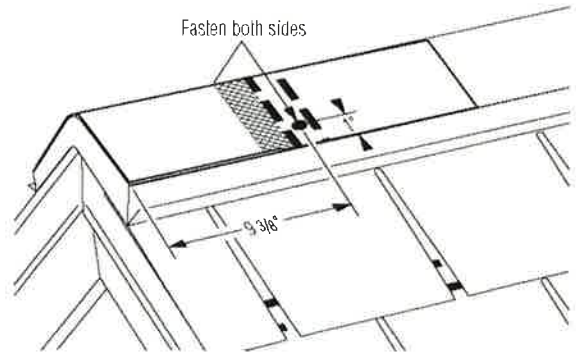

Figure 15-14: 18 three-piece units separate to make 54 Hatteras Accessory shingles.



**6.11.1.2 Option 2:** Cut Hatteras Shingles

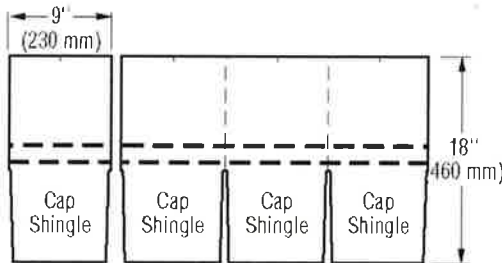

Figure 15-20: Cut Hatteras shingles to make cover cap.

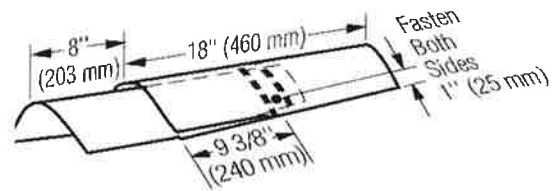

Figure 15-21: Installation of caps along hips and ridges.

6.11.1.3 For ASTM D3161, Class F performance use BASF "Sonolastic® NP1™" adhesive or Henkel "PL® Polyurethane Roof & Flashing Sealant", in accordance with CertainTeed requirements.

**6.12 HIGHLAND SLATE™, HIGHLAND SLATE™ IR:**

**LOW AND STANDARD SLOPE:**

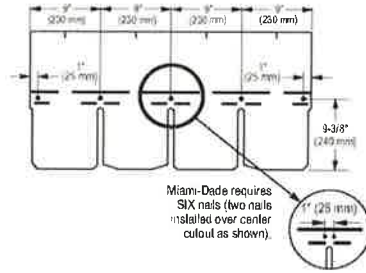

Figure 11-3: Use FIVE nails for every Highland Slate shingle.

**STEEP SLOPE:**

Use FIVE nails and EIGHT spots of asphalt roofing cement\* for each full Highland Slate shingle. For Miami-Dade, SIX nails are required. Apply 1" diameter spots of asphalt roofing cement under each tab corner. Asphalt roofing cement meeting ASTM D4586 Type II is suggested.

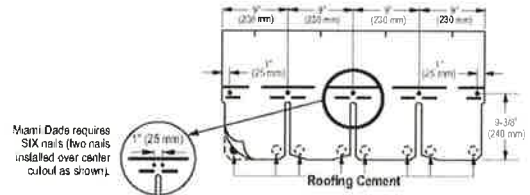

Figure 11-3A: Use FIVE nails and eight spots of asphalt roofing cement under each tab corner.

\*CAUTION: Excessive use of roofing cement can cause shingles to blister.

6.12.1 **Hip & Ridge for Highland Slate™, Highland Slate™ IR:** Refer to instructions herein for Cedar Crest™, Cedar Crest™ IR or Shangle Ridge™ hip and ridge shingles.

**6.13 PATRIOT™:**

**LOW AND STANDARD SLOPE**

Use FOUR nails for every full shingle located as shown below.

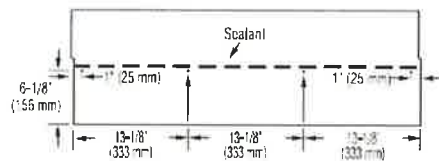

**STEEP SLOPE**

Use FOUR nails and four spots of asphalt roofing cement for every full shingle as shown below. Asphalt roofing cement meeting ASTM D4586 Type II is suggested. Apply 1" (25 mm) spots of asphalt roofing cement as shown.

CAUTION: Excessive use of roofing cement can cause shingles to blister.

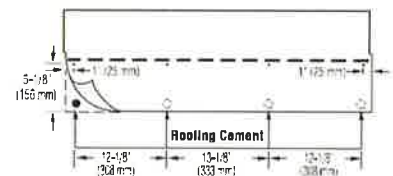

6.13.1 **Hip & Ridge for Patriot™:** Refer to instructions herein for Cedar Crest™, Cedar Crest™ IR, Shadow Ridge™, NorthGate or Shangle Ridge™ hip and ridge shingles.

**7. LABELING:**

- 7.1 Each unit shall bear a permanent label with the manufacturer's name, logo, city, state and logo of the Accredited Quality Assurance Agency noted herein.
- 7.2 Asphalt shingle wrappers shall indicate compliance with one of the required classifications detailed in FBC Table 1507.2.7.1 / R905.2.6.1.



**8. BUILDING PERMIT REQUIREMENTS:**

As required by the Building Official or Authority Having Jurisdiction in order to properly evaluate the installation of this product.

**9. MANUFACTURING PLANTS:**

Contact the named QA entity for information on which plants produce products covered by **Florida Rule 61G20-3** QA requirements.

**10. QUALITY ASSURANCE ENTITY:**

UL LLC – QUA9625; (414) 248-6409; karen.buchmann@us.ul.com

**- END OF EVALUATION REPORT -**



[BCIS Home](#)
[Log In](#)
[User Registration](#)
[Hot Topics](#)
[Submit Surcharge](#)
[Stats & Facts](#)
[Publications](#)
[FBC Staff](#)
[BCIS Site Map](#)
[Links](#)
[Search](#)



**Product Approval**  
USER: Public User

[Product Approval Menu](#) > 
 [Product or Application Search](#) > 
 [Application List](#) > 
 **Application Detail**

OFFICE OF THE SECRETARY

FL #	FL21841-R2						
Application Type	Revision						
Code Version	2017						
Application Status	Approved						
Comments	Archived						
Product Manufacturer	CertainTeed Corporation-Roofing						
Address/Phone/Email	20 Moores Road Malvern, PA 19355 (610) 893-5400 mark.d.harner@saint-gobain.com						
Authorized Signature	Mark Harner mark.d.harner@saint-gobain.com						
Technical Representative	Mark D. Harner						
Address/Phone/Email	18 Moores Road Malvern, PA 19355 (610) 651-5847 Mark.D.Harner@saint-gobain.com						
Quality Assurance Representative							
Address/Phone/Email							
Category	Roofing						
Subcategory	Underlayments						
Compliance Method	Evaluation Report from a Florida Registered Architect or a Licensed Florida Professional Engineer Evaluation Report - Hardcopy Received						
Florida Engineer or Architect Name who developed the Evaluation Report	Robert Nieminen						
Florida License	PE-59166						
Quality Assurance Entity	QAI Laboratories						
Quality Assurance Contract Expiration Date	01/01/2023						
Validated By	John W. Knezevich, PE ✓ Validation Checklist - Hardcopy Received						
Certificate of Independence	<a href="#">FL21841_R2_COI_2017_01_COI_Nieminen.pdf</a>						
Referenced Standard and Year (of Standard)	<table border="0"> <thead> <tr> <th><b>Standard</b></th> <th><b>Year</b></th> </tr> </thead> <tbody> <tr> <td>ASTM D1970 (tear)</td> <td>2015</td> </tr> <tr> <td>ASTM D226 (physicals)</td> <td>2009</td> </tr> </tbody> </table>	<b>Standard</b>	<b>Year</b>	ASTM D1970 (tear)	2015	ASTM D226 (physicals)	2009
<b>Standard</b>	<b>Year</b>						
ASTM D1970 (tear)	2015						
ASTM D226 (physicals)	2009						
Equivalence of Product Standards Certified By							
Sections from the Code							





**EXTERIOR RESEARCH & DESIGN, LLC.**

*Certificate of Authorization #9503*  
353 CHRISTIAN STREET, UNIT #13  
OXFORD, CT 06478  
(203) 262-9245

**EVALUATION REPORT**

**CertainTeed Corporation**

20 Moores Road  
Malvern, PA 19355  
**(610) 651-5847**

**Evaluation Report 13500.02.17-R2**

**FL21841-R2**

**Date of Issuance: 02/10/2017**

**Revision 2: 09/05/2017**

**SCOPE:**

This Evaluation Report is issued under **Rule 61G20-3** and the applicable rules and regulations governing the use of construction materials in the State of Florida. The documentation submitted has been reviewed by Robert Nieminen, P.E. for use of the product under the Florida Building Code and Florida Building Code, Residential Volume. The products described herein have been evaluated for compliance with the **6<sup>th</sup> Edition (2017) Florida Building Code** sections noted herein.

**DESCRIPTION: RoofRunner™ High Performance Synthetic Roofing Underlayment**

**LABELING:** Labeling shall be in accordance with the requirements the Accredited Quality Assurance Agency noted herein.

**CONTINUED COMPLIANCE:** This Evaluation Report is valid until such time as the named product(s) changes, the referenced Quality Assurance documentation changes, or provisions of the Code that relate to the product change. Acceptance of this Evaluation Report by the named client constitutes agreement to notify Robert Nieminen, P.E. if the product changes or the referenced Quality Assurance documentation changes. Trinity|ERD requires a complete review of this Evaluation Report relative to updated Code requirements with each Code Cycle.

**ADVERTISEMENT:** The Evaluation Report number preceded by the words "Trinity|ERD Evaluated" may be displayed in advertising literature. If any portion of the Evaluation Report is displayed, then it shall be done in its entirety.

**INSPECTION:** Upon request, a copy of this entire Evaluation Report shall be provided to the user by the manufacturer or its distributors and shall be available for inspection at the job site at the request of the Building Official.

This Evaluation Report consists of pages 1 through 3.

**Prepared by:**

**Robert J.M. Nieminen, P.E.**

*Florida Registration No. 59166, Florida DCA ANE1983*



The facsimile seal appearing was authorized by Robert Nieminen, P.E. on 09/05/2017. This does not serve as an electronically signed document.

**CERTIFICATION OF INDEPENDENCE:**

1. Trinity|ERD does not have, nor does it intend to acquire or will it acquire, a financial interest in any company manufacturing or distributing products it evaluates.
2. Trinity|ERD is not owned, operated or controlled by any company manufacturing or distributing products it evaluates.
3. Robert Nieminen, P.E. does not have nor will acquire, a financial interest in any company manufacturing or distributing products for which the evaluation reports are being issued.
4. Robert Nieminen, P.E. does not have, nor will acquire, a financial interest in any other entity involved in the approval process of the product.
5. This is a building code evaluation. Neither Trinity|ERD nor Robert Nieminen, P.E. are, in any way, the Designer of Record for any project on which this Evaluation Report, or previous versions thereof, is/was used for permitting or design guidance unless retained specifically for that purpose.

**ROOFING COMPONENT EVALUATION:**
**1. SCOPE:**
**Product Category:** Roofing

**Sub-Category:** Underlayment

**Compliance Statement:** RoofRunner™ High Performance Synthetic Roofing Underlayment, as produced by CertainTeed Corporation, has demonstrated compliance with the following sections of the 6<sup>th</sup> Edition (2017) Florida Building Code through testing in accordance with applicable sections of the following Standards. Compliance is subject to the Installation Requirements and Limitations / Conditions of Use set forth herein.

**2. STANDARDS:**

<u>Section</u>	<u>Properties</u>	<u>Standard</u>	<u>Year</u>
1507.2.3 / 1507.1.1	Unrolling, Breaking Strength, Pliability	ASTM D226	2009
1507.1.1	Tear strength	ASTM D1970	2015

**3. REFERENCES:**

<u>Entity</u>	<u>Examination</u>	<u>Reference</u>	<u>Date</u>
ERD (TST6049)	Tear strength	CTR-SC16080.17	07/31/2017
QAI (TST9808)	Physical Properties, AC188	RJ3502P-1	11/05/2014
QAI (QUA7628)	Traceability/Inspections	Service Confirmation	02/09/2017

**4. PRODUCT DESCRIPTION:**

- 4.1 **RoofRunner™** is a synthetic polymer-based scrim-reinforced underlayment designed for use on roof decks as a water-resistant layer beneath asphalt roofing shingles; meets ASTM D226 physical property requirements and ASTM D1970 tear strength per the **Exception of FBC 1507.1.1**. **RoofRunner™** consists of a woven polyolefin base with a layer of nonwoven polyolefin sheet and a polymer coating on the back side. **RoofRunner™** is available in rolls 48-inch x 250-ft; nominal unit weight of 2.25 lbs/square.

**5. LIMITATIONS:**

- 5.1 This is a building code evaluation. Neither Trinity|ERD nor Robert Nieminen, P.E. are, in any way, the Designer of Record for any project on which this Evaluation Report, or previous versions thereof, is/was used for permitting or design guidance unless retained specifically for that purpose.
- 5.2 This Evaluation Report is not for use in FBC HVHZ jurisdictions.
- 5.3 Fire Classification is not part of this Evaluation Report; refer to current Approved Roofing Materials Directory or test report from accredited testing/listing agency for fire ratings of this product.
- 5.4 **RoofRunner™** may be used with any prepared roof cover where the product is specifically referenced within FBC approval documents. If not listed, a request may be made to the Authority Having Jurisdiction for approval based on this evaluation combined with supporting data for the prepared roof covering.
- 5.5 **RoofRunner™** shall not be installed on roof slopes below 2:12.
- 5.6 **Allowable roof covers:**

TABLE 1: ROOF COVER OPTIONS						
Underlayment	Asphalt Shingles	Nail-On Tile	Foam-On Tile	Metal	Wood Shakes & Shingles	Slate
RoofRunner™	Yes	No	No	No	No	No

**5.7 Exposure Limitations:**

CertainTeed recommends primary roofing be installed within 48 hours of underlayment installation for re-roof applications or within 10-days of underlayment installation for new construction applications.

**6. INSTALLATION:**

- 6.1 **RoofRunner™ High Performance Synthetic Roofing Underlayment** shall be installed in accordance with **CertainTeed Corporation** published installation instructions subject to the Limitations set forth in Section 5 herein and the specifics noted below.
- 6.2 Install in compliance with the requirements for ASTM D226 underlayment in **FBC 1507.1.1**, taking into account the wider sheet-width of **RoofRunner™** for double-layer applications.
- 6.3 Re-fasten any loose decking panels, and check for protruding nail heads. Sweep the substrate thoroughly to remove any dust and debris prior to application.
- 6.4 Corrosion resistant fasteners shall be plastic cap nails with minimum 1-inch diameter head. **Do not use staples.** Ensure fasteners are installed at 90 degree angle to the deck with flush contact between the plastic cap or metal cap and the upper surface of the underlayment. Fasteners shall be of sufficient length to penetrate through the underside of plywood or OSB decks, or minimum ¾-inch embedment into dimensional lumber / tongue-and-groove wood decks.
- 6.5 Install a leak barrier of ASTM D1970, such as **CertainTeed WinterGuard (FL11288)**, or equal holding Florida Statewide Product Approval at vulnerable leak areas, including but not limited to eaves, valleys, rakes, skylights and dormers. At eaves and valleys, install the leak barrier prior to installation of **RoofRunner™**. Along the rake, install **RoofRunner™**, leaving 6 to 8-inch of the deck exposed, and then install the leak barrier over the **RoofRunner™** and exposed decking. At other areas, install the leak barrier over the **RoofRunner™**.
- 6.6 Single Layer; Roof Slope > 4:12:  
Starting at the eave, lay printed-side up and fasten at the circular targets printed on the top surface; 15-inch o.c. vertically and 12-inch o.c. horizontally (parallel to eaves). On vertical side/end laps install 8 fasteners equally spaced at 6-inch o.c. centered in the lap to hold the underlayment in place. Continue upslope in a similar manner, maintaining minimum 3-inch wide horizontal and minimum 6-inch wide vertical laps, and fasten as noted above. Offset vertical end laps from course to course at least 3 feet.
- 6.7 Double Layer; 2:12 < Roof Slope < 4:12:  
Starting at the eave, lay a 25.5-inch wide starter strip, printed-side up and fastened to hold in place. Then install a full 48-inch wide sheet, printed-side up, over the starter strip and fasten at the circular targets printed on the top surface; 15-inch o.c. vertically and 12-inch o.c. horizontally (parallel to eaves). On vertical side/end laps install 8 fasteners equally spaced at 6-inch o.c. centered in the lap to hold the underlayment in place. Continue upslope in a similar manner, maintaining minimum 25.5-inch wide horizontal laps (resulting in maximum 22.5-inch exposure) and minimum 12-inch wide vertical laps, and fasten as noted above. Offset vertical end laps from course to course at least 3 feet. Offset vertical end laps from course to course at least 3 feet.
- 6.8 **RoofRunner™** may not be used in any exposed application, including but not limited to crickets, exposed valleys or exposed roof to wall details.

**7. BUILDING PERMIT REQUIREMENTS:**

As required by the Building Official or Authority Having Jurisdiction in order to properly evaluate the installation of this product.

**8. MANUFACTURING PLANTS:**

Dadra, India

**9. QUALITY ASSURANCE ENTITY:**

Quality Auditing Institute, Ltd. – QUA7628; (604) 527-8378, [mlansdowne@qai.org](mailto:mlansdowne@qai.org)

- END OF EVALUATION REPORT -



**STATE OF FLORIDA  
DEPARTMENT OF BUSINESS AND PROFESSIONAL REGULATION**

**CONSTRUCTION INDUSTRY LICENSING BOARD  
2601 BLAIR STONE ROAD  
TALLAHASSEE FL 32399-0783**

**(850) 487-1395**

HEWITT, JEFFREY ALLAN  
GOLD KEY ROOFING LLC  
6021 SOUTH ORANGE AVENUE  
ORLANDO FL 32809

Congratulations! With this license you become one of the nearly one million Floridians licensed by the Department of Business and Professional Regulation. Our professionals and businesses range from architects to yacht brokers, from boxers to barbeque restaurants, and they keep Florida's economy strong.

Every day we work to improve the way we do business in order to serve you better. For information about our services, please log onto [www.myfloridalicense.com](http://www.myfloridalicense.com). There you can find more information about our divisions and the regulations that impact you, subscribe to department newsletters and learn more about the Department's initiatives.

Our mission at the Department is: License Efficiently, Regulate Fairly. We constantly strive to serve you better so that you can serve your customers. Thank you for doing business in Florida, and congratulations on your new license!



**STATE OF FLORIDA  
DEPARTMENT OF BUSINESS AND  
PROFESSIONAL REGULATION**

CCC1329157 ISSUED: 08/16/2016

**CERTIFIED ROOFING CONTRACTOR  
HEWITT, JEFFREY ALLAN  
GOLD KEY ROOFING LLC**

IS CERTIFIED under the provisions of Ch.489 FS.  
Expiration date AUG 31, 2018 L1608160002259

DETACH HERE

RICK SCOTT, GOVERNOR

KEN LAWSON, SECRETARY

**STATE OF FLORIDA  
DEPARTMENT OF BUSINESS AND PROFESSIONAL REGULATION  
CONSTRUCTION INDUSTRY LICENSING BOARD**

LICENSE NUMBER
CCC1329157

The ROOFING CONTRACTOR  
Named below IS CERTIFIED  
Under the provisions of Chapter 489 FS.  
Expiration date: AUG 31, 2018

HEWITT, JEFFREY ALLAN  
GOLD KEY ROOFING LLC  
6021 SOUTH ORANGE AVENUE  
ORLANDO FL 32809



ISSUED: 08/16/2016

DISPLAY AS REQUIRED BY LAW

SEQ # L1608160002259



# CERTIFICATE OF LIABILITY INSURANCE

DATE (MM/DD/YYYY)  
12/13/2017

THIS CERTIFICATE IS ISSUED AS A MATTER OF INFORMATION ONLY AND CONFERS NO RIGHTS UPON THE CERTIFICATE HOLDER. THIS CERTIFICATE DOES NOT AFFIRMATIVELY OR NEGATIVELY AMEND, EXTEND OR ALTER THE COVERAGE AFFORDED BY THE POLICIES BELOW. THIS CERTIFICATE OF INSURANCE DOES NOT CONSTITUTE A CONTRACT BETWEEN THE ISSUING INSURER(S), AUTHORIZED REPRESENTATIVE OR PRODUCER, AND THE CERTIFICATE HOLDER.

**IMPORTANT:** If the certificate holder is an ADDITIONAL INSURED, the policy(ies) must be endorsed. If SUBROGATION IS WAIVED, subject to the terms and conditions of the policy, certain policies may require an endorsement. A statement on this certificate does not confer rights to the certificate holder in lieu of such endorsement(s).

**PRODUCER**  
FRSA Self Insurers Fund, Inc.  
4099 Metric Drive  
Winter Park, FL 32792

**CONTACT NAME:** Debra Guidry, CPCU  
**PHONE (A/C, No, Ext):** (800) 767-3772 **FAX (A/C, No):** (407) 671-2520  
**E-MAIL ADDRESS:** debra@frsasif.com

**INSURED**  
Gold Key Roofing, LLC  
4874 S. Orange Avenue  
Orlando, FL 32806

**INSURER(S) AFFORDING COVERAGE**  
**INSURER A:** FRSA Self Insurers Fund / Evanston Insurance Co. **NAIC #** 35378  
**INSURER B:**  
**INSURER C:**  
**INSURER D:**  
**INSURER E:**  
**INSURER F:**

### COVERAGES

**CERTIFICATE NUMBER:**

**REVISION NUMBER:**

THIS IS TO CERTIFY THAT THE POLICIES OF INSURANCE LISTED BELOW HAVE BEEN ISSUED TO THE INSURED NAMED ABOVE FOR THE POLICY PERIOD INDICATED. NOTWITHSTANDING ANY REQUIREMENT, TERM OR CONDITION OF ANY CONTRACT OR OTHER DOCUMENT WITH RESPECT TO WHICH THIS CERTIFICATE MAY BE ISSUED OR MAY PERTAIN, THE INSURANCE AFFORDED BY THE POLICIES DESCRIBED HEREIN IS SUBJECT TO ALL THE TERMS, EXCLUSIONS AND CONDITIONS OF SUCH POLICIES. LIMITS SHOWN MAY HAVE BEEN REDUCED BY PAID CLAIMS.

INSR LTR	TYPE OF INSURANCE	ADDL INSD	SUBR WVD	POLICY NUMBER	POLICY EFF (MM/DD/YYYY)	POLICY EXP (MM/DD/YYYY)	LIMITS
	<b>COMMERCIAL GENERAL LIABILITY</b> <input type="checkbox"/> CLAIMS-MADE <input type="checkbox"/> OCCUR  GEN'L AGGREGATE LIMIT APPLIES PER: <input type="checkbox"/> POLICY <input type="checkbox"/> PRO-JECT <input type="checkbox"/> LOC OTHER:			N/A			EACH OCCURRENCE \$ DAMAGE TO RENTED PREMISES (Ea occurrence) \$ MED EXP (Any one person) \$ PERSONAL & ADV INJURY \$ GENERAL AGGREGATE \$ PRODUCTS - COMPIOP AGG \$ \$
	<b>AUTOMOBILE LIABILITY</b> <input type="checkbox"/> ANY AUTO <input type="checkbox"/> ALL OWNED AUTOS <input type="checkbox"/> HIRED AUTOS <input type="checkbox"/> SCHEDULED AUTOS <input type="checkbox"/> NON-OWNED AUTOS			N/A			COMBINED SINGLE LIMIT (Ea accident) \$ BODILY INJURY (Per person) \$ BODILY INJURY (Per accident) \$ PROPERTY DAMAGE (Per accident) \$ \$
	<b>UMBRELLA LIAB</b> <input type="checkbox"/> OCCUR <b>EXCESS LIAB</b> <input type="checkbox"/> CLAIMS-MADE DED RETENTION \$			N/A			EACH OCCURRENCE \$ AGGREGATE \$ \$
A	<b>WORKERS COMPENSATION AND EMPLOYERS' LIABILITY</b> ANY PROPRIETOR/PARTNER/EXECUTIVE OFFICER/MEMBER EXCLUDED? (Mandatory in NH) If yes, describe under DESCRIPTION OF OPERATIONS below	Y/N N	N/A	870-040079 / 3DY3150	01/01/2018	01/01/2019	<input checked="" type="checkbox"/> PER STATUTE <input type="checkbox"/> OTH-ER E.L. EACH ACCIDENT \$ 1,000,000 E.L. DISEASE - EA EMPLOYEE \$ 1,000,000 E.L. DISEASE - POLICY LIMIT \$ 1,000,000

DESCRIPTION OF OPERATIONS / LOCATIONS / VEHICLES (ACORD 101, Additional Remarks Schedule, may be attached if more space is required)

REMARKS: Non-cancelable, without 30 days prior written notice, except for non-payment of premium which will be a 10 day written notice.

Jeffrey Allan Hewitt, Qualifier  
Lic #CCC1329157

### CERTIFICATE HOLDER

Attn:  
  
City of Belle Isle  
1600 Nela Ave.  
Belle Isle, FL 32809

### CANCELLATION

SHOULD ANY OF THE ABOVE DESCRIBED POLICIES BE CANCELLED BEFORE THE EXPIRATION DATE THEREOF, NOTICE WILL BE DELIVERED IN ACCORDANCE WITH THE POLICY PROVISIONS.

AUTHORIZED REPRESENTATIVE  
Debra Guidry CPCU  
Underwriting Manager



# CERTIFICATE OF LIABILITY INSURANCE

DATE (MM/DD/YYYY)

2/15/2018

THIS CERTIFICATE IS ISSUED AS A MATTER OF INFORMATION ONLY AND CONFERS NO RIGHTS UPON THE CERTIFICATE HOLDER. THIS CERTIFICATE DOES NOT AFFIRMATIVELY OR NEGATIVELY AMEND, EXTEND OR ALTER THE COVERAGE AFFORDED BY THE POLICIES BELOW. THIS CERTIFICATE OF INSURANCE DOES NOT CONSTITUTE A CONTRACT BETWEEN THE ISSUING INSURER(S), AUTHORIZED REPRESENTATIVE OR PRODUCER, AND THE CERTIFICATE HOLDER.

**IMPORTANT:** If the certificate holder is an ADDITIONAL INSURED, the policy(ies) must be endorsed. If SUBROGATION IS WAIVED, subject to the terms and conditions of the policy, certain policies may require an endorsement. A statement on this certificate does not confer rights to the certificate holder in lieu of such endorsement(s).

## PRODUCER

Frank H. Furman, Inc.  
1314 East Atlantic Blvd.  
P. O. Box 1927

Pompano Beach FL 33061

## INSURED

Gold Key Roofing, LLC Gold Key International Inc  
4874 S. Orange Avenue

Orlando

FL 32806

## CONTACT

NAME: Griselidys Acosta

PHONE (A/C, No, Ext): (954) 943-5050

FAX (A/C, No): (954) 942-6310

E-MAIL ADDRESS: gris@furmaninsurance.com

## INSURER(S) AFFORDING COVERAGE

NAIC #

INSURER A: Security National Insurance Company 33120

INSURER B: MAFFRE

INSURER C:

INSURER D:

INSURER E:

INSURER F:

## COVERAGES

CERTIFICATE NUMBER: 18/19 MASTER

REVISION NUMBER:

THIS IS TO CERTIFY THAT THE POLICIES OF INSURANCE LISTED BELOW HAVE BEEN ISSUED TO THE INSURED NAMED ABOVE FOR THE POLICY PERIOD INDICATED. NOTWITHSTANDING ANY REQUIREMENT, TERM OR CONDITION OF ANY CONTRACT OR OTHER DOCUMENT WITH RESPECT TO WHICH THIS CERTIFICATE MAY BE ISSUED OR MAY PERTAIN, THE INSURANCE AFFORDED BY THE POLICIES DESCRIBED HEREIN IS SUBJECT TO ALL THE TERMS, EXCLUSIONS AND CONDITIONS OF SUCH POLICIES. LIMITS SHOWN MAY HAVE BEEN REDUCED BY PAID CLAIMS.

INSR LTR	TYPE OF INSURANCE	ADDL SUBR INSD WVD	POLICY NUMBER	POLICY EFF (MM/DD/YYYY)	POLICY EXP (MM/DD/YYYY)	LIMITS
X	COMMERCIAL GENERAL LIABILITY					
A	CLAIMS-MADE X OCCUR		SES154145300	2/19/2018	2/19/2019	EACH OCCURRENCE \$ 1,000,000 DAMAGE TO RENTED PREMISES (Ea occurrence) \$ 100,000 MED EXP (Any one person) \$ 5,000 PERSONAL & ADV INJURY \$ 1,000,000 GENERAL AGGREGATE \$ 2,000,000 PRODUCTS - COMP/OP AGG \$ 2,000,000 Employee Benefits Liability \$ 1,000,000
GEN'L AGGREGATE LIMIT APPLIES PER: POLICY X PRO-JECT LOC						
OTHER:						
B	AUTOMOBILE LIABILITY					
X	ANY AUTO					
	ALL OWNED AUTOS		5204070002276	2/19/2018	2/19/2019	COMBINED SINGLE LIMIT (Ea accident) \$ 1,000,000 BODILY INJURY (Per person) \$ BODILY INJURY (Per accident) \$ PROPERTY DAMAGE (Per accident) \$ PIP-Basic \$ 10,000
X	HIRED AUTOS	X				
	SCHEDULED AUTOS					
	NON-OWNED AUTOS					
	UMBRELLA LIAB OCCUR					EACH OCCURRENCE \$ AGGREGATE \$
	EXCESS LIAB CLAIMS-MADE					
	DED RETENTION S					
	WORKERS COMPENSATION AND EMPLOYERS' LIABILITY					
	ANY PROPRIETOR/PARTNER/EXECUTIVE OFFICER/MEMBER EXCLUDED? (Mandatory in NH)	Y/N	N/A			PER STATUTE OTH-ER E.L. EACH ACCIDENT \$ E.L. DISEASE - EA EMPLOYEE \$ E.L. DISEASE - POLICY LIMIT \$
	If yes, describe under DESCRIPTION OF OPERATIONS below					

DESCRIPTION OF OPERATIONS / LOCATIONS / VEHICLES (ACORD 101, Additional Remarks Schedule, may be attached if more space is required)

## CERTIFICATE HOLDER

City of Belle Isle  
1600 Nela Ave  
Orlando, FL 32809

## CANCELLATION

SHOULD ANY OF THE ABOVE DESCRIBED POLICIES BE CANCELLED BEFORE THE EXPIRATION DATE THEREOF, NOTICE WILL BE DELIVERED IN ACCORDANCE WITH THE POLICY PROVISIONS.

AUTHORIZED REPRESENTATIVE

Dirk DeJong/GA

ACORD 25 (2014/01)  
INS025 (201401)

The ACORD name and logo are registered marks of ACORD

© 1988-2014 ACORD CORPORATION. All rights reserved.

Harry W. Hewitt  
(407)851-0680

**CITY OF EDGEWOOD**  
LOCAL BUSINESS TAX RECEIPT

No: 1872

405 LARUE AVENUE, EDGEWOOD FL 32809-3406

Date: 8/14/17

LICENSE YEAR: OCT 1, 2017 - SEPT 30, 2018

Address: 4874 S. Orange Avenue  
EDGEWOOD FL 32806  
Activity: ROOFING AND CONSTRUCTION

BUS TAX 98.12  
PENALTY  
TRANSFER



Total Paid 98.12  
October 1 0.00  
November 1 0.00  
December 1 0.00  
January 1 0.00

Issued to: Gold Key Roofing  
Harry W. Hewitt  
4874 S. Orange Avenue  
EDGEWOOD FL 32806

*Bea L. Meeks*

Bea L. Meeks, CBTO, City Clerk

A

MUST BE POSTED CONSPICUOUSLY AT PLACE OF BUSINESS



- Searches
- Sales Search
- Results
- Property Record Card
- My Favorites

Sign up for e-Notify...

### 3519 Cullen Lake Shore Dr < 17-23-30-4380-04-180 >

Name(s): George Charles William  
 Goerge Rose Ellen  
 Mailing Address On File: 3519 Cullen Lake Shore Dr  
 Belle Isle, FL 32812-1112  
 Incorrect Mailing Address?

Physical Street Address: 3519 Cullen Lake Shore Dr  
 Postal City and Zipcode: Orlando, FL 32812  
 Property Use: 0103 - Single Fam Class III  
 Municipality: Belle Isle

SAVE PRINT SEND  
 MAP STREET VIEW  
 FAVORITES TRIM FCBT  
 PRINTIMATE FAXES SETTINGS  
 OLD MAP



[View 2017 Property Record Card](#)

- Property Features
- Values, Exemptions and Taxes**
- Sales Analysis
- Location Info
- Market Stats
- Update Information

2018 values will be available in August of 2018.

#### Property Description

[View Plat](#)

LAKE CONWAY ESTATES SECTION TWO REPLAT X/150 LOT 18 BLK D & LAND ON N TO LAKE & BEG SE COR TH RUN N 35 DEG W 155.72 FT TH NELY ALONG LAKE 34 FT TO NW COR LOT 82 CONWAY WOODS PB 4/42 TH SELY ALONG W LINE SAID LOT 82 TO SW COR TH SWLY 34 FT TO POB

Total Land Area 21,618 sqft (+/-) | 0.50 acres (+/-) GIS Calculated Notice

#### Land

Land Use Code	Zoning	Land Units	Unit Price	Land Value	Class Unit Price	Class Value
0130 - Sfr - Lake Front	R-1-AA	1 LOT(S)	working...	working...	working...	working...

Page 1 of 1 (1 total records)

#### Buildings

Important Information		Structure			
	Model Code: 01 - Single Fam Residence	Actual Year Built:	1962	Gross Area:	5381 sqft
	Type Code: 0103 - Single Fam Class III	Beds:	4	Living Area:	4631 sqft
	Building Value: working...	Baths:	4.5	Exterior Wall:	Concrete Block Stucco
	Estimated New Cost: working...	Floors:	2	Interior Wall:	Wood Panel

Page 1 of 1 (1 total records)

#### Extra Features

Description	Date Built	Units	XFOB Value
FPL2 - Average Fireplace	01/01/1962	1 Unit(s)	working...
BD2 - Boat Dock 2	02/17/1994	1 Unit(s)	working...
BC3 - Boat Cover 3	01/01/1994	1 Unit(s)	working...
PT2 - Patio 2	01/01/1994	1 Unit(s)	working...

Page 1 of 1 (4 total records)