



City of Belle Isle  
 Universal Engineering Sciences 3532 Maggie Blvd., Orlando, FL 32811  
 Tel 407-581-8161 \* Fax 407-581-0313 \* www.universalengineering.com

# PERMIT CARD - PLEASE POST AT JOB SITE

THIS DOCUMENT BECOMES YOUR PERMIT WHEN PROPERLY VALIDATED

Per FBC 105 3: An enforcing authority may not issue a building permit for any building construction, erection, alteration, modification, repair or addition unless the permit either includes on its face or there is attached to the permit the following statement: "NOTICE: In addition to the requirements of this permit, there may be additional restrictions applicable to this property that may be found in the public records of this county, and there may be additional permits required from other governmental entities such as water management districts, state agencies, or federal agencies." The issuance of this permit does not grant permission to violate any applicable City, Orange County, State of Florida and/or Federal codes and/or ordinances. Separate permits are required for Signs, Roofing, Electrical, Gas, Plumbing and Mechanical services. This permit becomes VOID if the work authorized is not commenced within 6 months, or is suspended or abandoned for a period of 6 months after commencement. WORK SHALL BE CONSIDERED SUSPENDED IF AN APPROVED INSPECTION HAS NOT BEEN MADE WITHIN A 6 MONTH PERIOD. PERMISSION IS GRANTED TO DO THE FOLLOWING WORK ACCORDING TO THE CONDITIONS HEREON AND THE APPROVED PLANS AND SPECIFICATIONS, SUBJECT TO COMPLIANCE WITH THE ORDINANCES OF THE CITY OF BELLE ISLE, FLORIDA.

<b>Scope of Work:</b> ROOF: retrofit, 33sf asphalt shingles  <b>Comments:</b> None  <b>Project Information</b> Address: 7212 Conway Circle, Belle Isle, FL 32809 Parcel ID: 25-23-29-5884-14-100 Property Owner: Klemm, Eddie Phone Number: n/a ***** Company Name: E&V Roofing Company, Inc. Contractor Name: Ortiz, Refugio License Number: CCC1327124 Address: 119 Honey Wood Circle, Kissimmee, FL 34743 Phone Number: 407-738-6320	<b>Permit Number: 2015-07-051</b> <b>Date of Application: 07/20/2015</b> <b>Date Permit Issued: 08/25/2015</b>  <b>WARNING TO OWNER:</b> "YOUR FAILURE TO RECORD A NOTICE OF COMMENCEMENT MAY RESULT IN YOU PAYING TWICE FOR IMPROVEMENTS TO YOUR PROPERTY. IF YOU INTEND TO OBTAIN FINANCING, CONSULT WITH YOUR LENDER OR AN ATTORNEY BEFORE RECORDING YOUR NOTICE OF COMMENCEMENT." ON THE JOB INSPECTION(S) MUST BE MADE BEFORE PROCEEDING WITH SUBSEQUENT WORK. THIS CARD MUST BE DISPLAYED OUTSIDE AND BE PROTECTED FROM THE WEATHER WHILE BEING VISIBLE FROM THE STREET UNTIL THE FINAL INSPECTIONS HAVE BEEN APPROVED.
---	---

### BUILDING FEATURES

<b>IMPACT FEES</b> Traffic \$ School \$  <b>ZONING FEES</b> Zoning Fee \$30.00  <b>UNIVERSAL ENG - BUILDING FEES</b> Boat Dock \$ Boat House \$ Building \$ Demo \$ Door(s) \$ Driveway \$ Electrical \$ Fence \$ Gas \$ Irrigation \$ Low Voltage \$ Mechanical \$ Plumbing \$ Pool \$ Roofing \$35.00 Screen Encl \$ Shed \$ Temp Pole \$ Window(s) \$  <b>SURCHARGE FEES</b> Surcharge Fee \$2.00 Surcharge Fee \$2.00  <b>TOTAL FEES \$69.00</b>  Date Paid 8/25/15 Color Check # VISA 9190 Amount Paid \$69.00	<b>BUILDING INSPECTOR USE ONLY</b>  IF APPLICABLE: Have Zoning Approval Conditions Been Met? YES NO Have Stormwater Approval Conditions Been Met? YES NO Silt fencing in place? YES NO Turbidity Barrier in place? YES NO  BUILDING 1 <sup>st</sup> _____ (Footing/Foundation) Survey specific foundation plan must be onsite before slab pour. Approved Plan on Site? _____ 2 <sup>nd</sup> _____ (Slab) 3 <sup>rd</sup> _____ (Lintel)(Wall Reinforcing on Masonry Building) 4 <sup>th</sup> _____ (Exterior Framing)(Roof/Wall Sheathing) 5 <sup>th</sup> _____ (Framing) (To be made after Plumbing/ Mechanical/ Electrical Rough-Ins & Windows/Doors Installed) 6 <sup>th</sup> _____ (Insulation to be Made After Roof Installed) 7 <sup>th</sup> _____ (Drywall) 8 <sup>th</sup> _____ (Sidewalk/Driveway) 9 <sup>th</sup> _____ (Other) 10 <sup>th</sup> _____ (Final - After MEP and Other Applicable Finals)  <b>ROOFING OSHA APPROVED ACCESS MUST BE MADE AVAILABLE TO INSPECTOR</b> 1 <sup>ST</sup> ROOFING Deck Nailing/Dry-in/Flashing _____ 2 <sup>ND</sup> ROOFING Covering In-Progress _____ 3 <sup>RD</sup> ROOFING Covering Final _____  PLUMBING (Pool-Piping, Solar, Irrigation, Water Treatment Equip, Etc...) 1 <sup>ST</sup> _____ (Underground) 2 <sup>ND</sup> _____ (Sewer) 3 <sup>RD</sup> _____ (Rough-In/Tub Set) 4 <sup>TH</sup> _____ (Final)  CHECK APPROPRIATE BOX <input type="checkbox"/> GAS <input type="checkbox"/> Natural <input type="checkbox"/> LP <input type="checkbox"/> MECHANICAL <input type="checkbox"/> ELECTRICAL <input type="checkbox"/> LOW VOLTAGE 1 <sup>st</sup> _____ (Rough-In) 2 <sup>nd</sup> _____ (Final)
---	---

The person accepting this permit shall conform to the terms of the application on file and construction shall conform to the requirements of the Florida Building Code (F-S 553).

Inspection requests are to be emailed to [BidScheduling@UniversalEngineering.com](mailto:BidScheduling@UniversalEngineering.com); a confirmation email will be sent back to you upon scheduling. Next-Day Inspection requests must be made by 1pm. Please include the following in your request: Permit #, project address, type of inspection, date of the requested inspection, a contact name & a contact phone number. AM or PM may be requested but cannot be guaranteed.

For a copy of your permit, or to check inspection results, please visit <https://universalengineering.sharefile.com>  
 login ID = [cobi@universalengineering.com](mailto:cobi@universalengineering.com) password = [universall13](https://universalengineering.sharefile.com)

**CITY OF BELLE ISLE**  
**Permit Application Review Sheet**

Permit Number	
Property Owner	
Address	
Nature of Improvement	
Received Application	
Sent for Stormwater Review	
Stormwater Approved	
Sent for Zoning Review	
Zoning Approved	
Applied for Variance	
Variance Approved	
Sent to BO for Review	
Building Official Approved	
	<b>Comments</b>
1. <del>1944</del> 8/25/15	Typed Permit Card, Updated Log!
2. " "	Vision, Emailed Client its Ready.
3. <del>1944</del> 8/25/15	Payment Received, Update Log/Vision
4. " "	Emailed Permit, Scanned for Sharefile.
5.	
6.	
7.	
8.	
9.	
10.	
11.	
12.	

*Page 2*

CITY OF BELLE ISLE  
Permit Application Review Sheet

Permit Number	2015-07-051
Property Owner	KLEMM, Eddie
Address	7212 Conway Circle (32809)
Nature of Improvement	Roof: re-roof; 33SF asphalt shingles
Received Application	7/24/15
Sent for Stormwater Review	/
Stormwater Approved	Page 1
Sent for Zoning Review	/
Zoning Approved	
Applied for Variance	
Variance Approved	
Sent to BO for Review	7/24/15
Building Official Approved	ca 8-5-15
Comments	
1. 1944. 7/24/15	Logged in, Created Proj. # + Task, Emailed
2. " "	client we need Revised GL; Grave to Collina.
3. ca 7-24-15	need Shingle installation instructions
4. " "	+ underlayement screen shot - both
5. " "	from www.HorndalBuilding.org
6. 1944 7/24/15	Emailed Client Asking For Required
7. " "	Paperwork.
8. 1944. 8/5/15	Rec'd current product paperwork;
9. " "	Grave to Collina; still need GL
10. ca 8-5-15	need to verify contractor docs on app
11. Sam 8-21-15	all credentials rec'd
12. " "	please advise if this can be

Issued now

Karina: 321-356-6773



# City of Belle Isle

Universal Engineering Sciences 3532 Maggie Blvd., Orlando, FL 32811  
Tel 407-581-8161 \* Fax 407-581-0313 \* [www.universalengineering.com](http://www.universalengineering.com)

## APPLICATION FOR ROOFING PERMIT

WARNING TO OWNER: YOUR FAILURE TO RECORD A NOTICE OF COMMENCEMENT MAY RESULT IN YOUR PAYING TWICE FOR IMPROVEMENTS TO YOUR PROPERTY. A NOTICE OF COMMENCEMENT MUST BE RECORDED AND POSTED ON THE JOB SITE BEFORE THE FIRST INSPECTION. IF YOU INTEND TO OBTAIN FINANCING, CONSULT WITH YOUR LENDER OR AN ATTORNEY BEFORE RECORDING YOUR NOTICE OF COMMENCEMENT.

DATE OF APPLICATION: 2-20-15 ROOF PERMIT NUMBER: 2015-07-051  
PLEASE PRINT. The undersigned hereby applies for a permit to make installations as indicated below:

Project Address 7212 Conway Cir Belle Isle, FL  32809  32812

Property Owner Klemm Eddie Phone \_\_\_\_\_

Property Owner's Mailing Address 7212 Conway Cir City Belle Isle

State FL Zip Code 32809 Parcel Id Number: 25-23-29-5884-14-100

REQUIRED! To obtain this information, please visit <http://www.ocpafll.org/Searches/ParcelSearch.aspx>

Class of Building: Old  New  Type of Building: Residential  Commercial  Other   
Type of Work: New Roof  ReRoof

- REQUIRED! Florida Product Approval Screen Printout from [www.floridabuilding.org](http://www.floridabuilding.org) showing the Code Version
- REQUIRED! Florida Product Approval Installation Instructions from [www.floridabuilding.org](http://www.floridabuilding.org) (not the manufacturer instructions)
- REQUIRED! Copies of your General Liability & Worker's Comp Insurance Certificate & State and Local Licenses

Please indicate the nature of work by completing the information below:

Roof Square Footage: 33 Number of Stories: 1 Job Valuation: \$ 2450.00

Type: Asphalt Shingles  Metal  Modified Bitumen  Other: \_\_\_\_\_

I hereby certify that the above is true and correct to the best of my knowledge and make Application for Permit as outlined above, and if same is granted I agree to conform to all Florida Building Code Regulations and City Ordinances regulating same and in accordance with plans submitted. The issuance of this permit does not grant permission to violate any applicable Town and/or State of Florida codes and/or ordinances. By signing below, I recognize Republic Services is by legal contract the sole authorized provider of garbage, recycling, yard waste, and commercial garbage and construction debris collection and disposal services with the city limits of the City. Contractors, homeowners and commercial businesses may contact Republic Services at 407-293-8000 to setup accounts for Commercial, Construction Roll Off, or other services needed. Rates are fixed by contract and are available at City Hall or from Republic Services. The City enforces the contract through its code enforcement office. Failure to comply will result in a stop work order.

LICENSE HOLDER SIGNATURE [Signature] LICENSE # CCC1327124

LICENSE HOLDER NAME Refugio Ortiz COMPANY NAME E&V Roofing Company Inc

Street Address 119 Honey Wood Cir

City Kissimmee State FL Zip Code 34743 Phone Number 407-738-6320

Email Address Unique-permitting@gmail.com

Building Official: <u>sq</u>	Date <u>8-5-15</u>
Verified Contractor's Licenses & Insurance are on file <u>JOH.</u> Date <u>8/25/15</u>	
Zoning Fee	\$ <u>30<sup>00</sup></u>
Permit Fee	\$ <u>35<sup>00</sup></u>
Review Fee	\$ <u>n/a</u>
3% Florida Surcharge	\$ <u>4<sup>00</sup></u>
Total Permit Fee	\$ <u>69<sup>00</sup></u>

NOTE: The Building Permit Number is required if the Roof Installation is associated with any construction or alteration where a Building Permit has been issued. Building Permit Number \_\_\_\_\_



**City of Belle Isle**  
 Universal Engineering Sciences 3532 Maggie Blvd., Orlando, FL 32811  
 Tel 407-581-8161 \* Fax 407-581-0313 \* [www.universaleengineering.com](http://www.universaleengineering.com)

## Product Approval Form

DATE: 7-20-15

PERMIT # \_\_\_\_\_

PROJECT ADDRESS 7212 Conway Cir

Belle Isle, FL  32809  32812

As required by Florida Statute 553.842 and Florida Administrative Code 9B-72m, please provide the information and approval numbers of the building components listed below if they will be utilized on the building or structure. FL Approved products are listed online at [www.floridabuilding.org](http://www.floridabuilding.org) or can be obtained from the local product supplier. The following information must be turned in with permit application and available onsite for inspections:

1. This Product Approval Cover Sheet
2. Internet screen from [FloridaBuilding.org](http://FloridaBuilding.org) showing PA#, approval and code edition stamped
3. Manufacturer's Installation details from [FloridaBuilding.org](http://FloridaBuilding.org) and requirements for each product stamped

Product Type	Manufacturer	Model/Series	FL Product Approval #	Product Type	Manufacturer	Model/Series	FL Product Approval #
<b>EXTERIOR DOORS</b>							
Swinging				Sliding	<b>WALL PANELS</b>		
Sliding				Soffits			
Sectional/Rollup				Storefront			
Other				Glass Block			
				Other			
<b>WINDOWS</b>							
Single/Dbt Hung				Asphalt Shingles	Owens Corning		FL16074.R10
Horizontal Slider				Non Struct Metal			
Casement				Roofing Tiles			
Fixed				Single Ply Roof			
Mullion				Other			
Skylights				Underlayments	Tamko		FL12328.R5
Other							
<b>STRUCTURAL COMPONENTS</b>							
Wood Connectors				<b>OTHER</b>			
Wood Anchors							
Truss Plates							
Insulation Forms							
Lintels							
Other							

It is the applicant's responsibility to verify that specific products have been installed in accordance with their limitations and with the minimum required design pressures for the structure. Specific compliance will be verified during field inspections.

Applicant Signature  Date 7-20-15



OFFICE OF THE SECRETARY

BCIS Home | Log In | User Registration | Hot Topics | Submit Surcharge | Stats & Facts | Publications | FBC Staff | BCIS Site Map | Links | Search



Lower efficiency. Regulate better.

Product Approval Menu > Product or Application Search > Application List > Application Detail

FL #  
Application Type  
Code Version  
Application Status

FL10674-R10  
Revision  
2014  
Approved

Comments  
Archived



Product Manufacturer  
Address/Phone/Email

Owens Corning  
One Owens Corning Parkway  
Toledo, OH 43659  
(740) 404-7829  
greg.keeler@owenscorning.com

Authorized Signature

Greg Keeler  
greg.keeler@owenscorning.com

Technical Representative  
Address/Phone/Email

Mel Sancrant  
1 Owens Corning PKWY  
Toledo, OH 43659  
(419) 376-8360  
mel.sancrant@owenscorning.com

Quality Assurance Representative  
Address/Phone/Email

Category  
Subcategory

Roofing  
Asphalt Shingles

Compliance Method

Evaluation Report from a Florida Registered Architect or a Licensed Florida Professional Engineer  
 Evaluation Report - Hardcopy Received

Florida Engineer or Architect Name who developed the Evaluation Report

Robert J.M. Nieminen

Florida License

PE-59166

Quality Assurance Entity

UL LLC

Quality Assurance Contract Expiration Date

08/20/2017

Validated By

John W. Knezevich, PE

Validation Checklist - Hardcopy Received

Certificate of Independence

FL10674\_R10\_COI\_2015\_01\_COI\_Nieminen.pdf

Referenced Standard and Year (of Standard)

Standard	Year
ASTM D3161	2009
ASTM D3462	2009
ASTM D7158	2008

Equivalence of Product Standards Certified By

Sections from the Code

Product Approval Method

Method 1 Option D

Date Submitted

04/22/2015

Date Validated

04/23/2015

Date Pending FBC Approval

04/25/2015

Date Approved

06/23/2015

**Summary of Products**

FL #	Model, Number or Name	Description
10674.1	Owens Corning Asphalt Roofing Shingles and Starters	3-tab, 4-tab, 5-tab, laminated, starter and hip & ridge shingles
<p><b>Limits of Use</b>                      Approved for use in HVHZ: No                      Approved for use outside HVHZ: Yes                      Impact Resistant: N/A                      Design Pressure: N/A                      Other: Refer to ER, Section 5.</p> <p><b>Installation Instructions</b>                      FL10674_R10_IL_2015_04_FINAL_ER_OC ASPHALT SHINGLES_FL10674-R10.pdf                      Verified By: Robert J. M. Nieminen PE - 59166                      Created by Independent Third Party: Yes</p> <p><b>Evaluation Reports</b>                      FL10674_R10_AE_2015_04_FINAL_ER_OC ASPHALT SHINGLES_FL10674-R10.pdf                      Created by Independent Third Party: Yes</p>		

[Back](#)

[Next](#)

[Contact Us](#) :: [1940 North Monroe Street, Tallahassee, FL 32399](#) Phone: 850-487-1824

The State of Florida is an AA/EEO employer. [Copyright 2007-2013, State of Florida.](#) :: [Privacy Statement](#) :: [Accessibility Statement](#) :: [Refund Statement](#)

Under Florida law, email addresses are public records. If you do not want your e-mail address released in response to a public-records request, do not send electronic mail to this entity. Instead, contact the office by phone or by traditional mail. If you have any questions, please contact 850.487.1395. \*Pursuant to Section 455.275(1), Florida Statutes, effective October 1, 2012, licensees licensed under Chapter 455, F.S., must provide the Department with an email address if they have one. The emails provided may be used for official communication with the licensee. However email addresses are public record. If you do not wish to supply a personal address, please provide the Department with an email address which can be made available to the public. To determine if you are a licensee under Chapter 455, F.S., please click [here](#).

**Product Approval Accepts:**





**EXTERIOR RESEARCH & DESIGN, LLC.**  
*Certificate of Authorization #9503*  
353 CHRISTIAN STREET, UNIT #13  
OXFORD, CT 06478  
PHONE: (203) 262-9245  
FAX: (203) 262-9243

**EVALUATION REPORT**

**Owens Corning**  
One Owens Corning Parkway  
Toledo, OH 43659

**Evaluation Report O37940.02.12-R5**  
**FL10674-R10**  
**Date of Issuance: 02/06/2012**  
**Revision 5: 04/22/2015**

**SCOPE:**

This Evaluation Report is issued under Rule 61G20-3 and the applicable rules and regulations governing the use of construction materials in the State of Florida. The documentation submitted has been reviewed by Robert Nieminen, P.E. for use of the product under the Florida Building Code and Florida Building Code, Residential Volume. The products described herein have been evaluated for compliance with the 5<sup>th</sup> Edition (2014) Florida Building Code sections noted herein.

**DESCRIPTION: Owens Corning Asphalt Roof Shingles**

**LABELING:** Labeling shall be in accordance with the requirements the Accredited Quality Assurance Agency noted herein.

**CONTINUED COMPLIANCE:** This Evaluation Report is valid until such time as the named product(s) changes, the referenced Quality Assurance documentation changes, or provisions of the Code that relate to the product change. Acceptance of this Evaluation Report by the named client constitutes agreement to notify Robert Nieminen, P.E. if the product changes or the referenced Quality Assurance documentation changes. Trinity|ERD requires a complete review of this Evaluation Report relative to updated Code requirements with each Code Cycle.

**ADVERTISEMENT:** The Evaluation Report number preceded by the words "Trinity|ERD Evaluated" may be displayed in advertising literature. If any portion of the Evaluation Report is displayed, then it shall be done in its entirety.

**INSPECTION:** Upon request, a copy of this entire Evaluation Report shall be provided to the user by the manufacturer or its distributors and shall be available for inspection at the job site at the request of the Building Official.

This Evaluation Report consists of pages 1 through 6.

**Prepared by:**

**Robert J.M. Nieminen, P.E.**  
*Florida Registration No. 59166, Florida DCA ANE1983*

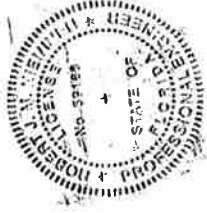

The facsimile seal appearing was authorized by Robert Nieminen, P.E. on 04/22/2015. This does not serve as an electronically signed document. Signed, sealed hardcopies have been transmitted to the Product Approval Administrator and to the named client.

**CERTIFICATION OF INDEPENDENCE:**

1. Trinity|ERD does not have, nor does it intend to acquire or will it acquire, a financial interest in any company manufacturing or distributing products it evaluates.
2. Trinity|ERD is not owned, operated or controlled by any company manufacturing or distributing products it evaluates.
3. Robert Nieminen, P.E. does not have nor will acquire, a financial interest in any company manufacturing or distributing products for which the evaluation reports are being issued.
4. Robert Nieminen, P.E. does not have, nor will acquire, a financial interest in any other entity involved in the approval process of the product.
5. This is a building code evaluation. Neither Trinity|ERD nor Robert Nieminen, P.E. are, in any way, the Designer of Record for any project on which this Evaluation Report, or previous versions thereof, is/was used for permitting or design guidance unless retained specifically for that purpose.

**ROOFING SYSTEMS EVALUATION:**

**1. SCOPE:**

**Product Category:** Roofing  
**Sub-Category:** Asphalt Shingles

**Compliance Statement:** Owens Corning Asphalt Roof Shingles, as produced by Owens Corning, have demonstrated compliance with the following sections of the Florida Building Code and Florida Building Code, Residential Volume through testing in accordance with the following Standards. Compliance is subject to the Installation Requirements and Limitations / Conditions of Use set forth herein.

**2. STANDARDS:**

<u>Section</u>	<u>Property</u>	<u>Standard</u>	<u>Year</u>
1507.2.5, R905.2.4	Physical Properties	ASTM D3462	2009
1507.2.7.1, R905.2.6.1	Wind Resistance	ASTM D3161	2009
1507.2.7.1, R905.2.6.1	Wind Resistance	ASTM D7158	2008

**3. REFERENCES:**

<u>Entity</u>	<u>Examination</u>	<u>Reference</u>	<u>Date</u>
UL LLC (CER9626)	Physicals & Wind Resistance	File R2453, Vol. 3	02/15/2007
UL LLC (CER9626)	Physicals & Wind Resistance	20120516-R2453	05/16/2012
UL LLC (TST9628)	Physical Properties	06CA20263	04/18/2006
UL LLC (TST9628)	Wind Resistance	11CA34308	02/18/2012
UL LLC (TST9628)	Physicals & Wind Resistance	4786093137	02/01/2014
UL LLC (TST9628)	Wind Resistance	4786126532	02/10/2014
UL LLC (TST9628)	Physical Properties	Classification letter	02/13/2014
Miami-Dade (CER1592)	FBC HVHZ Compliance	Various NOAs	Various
UL LLC (QUA9625)	Quality Control	Service Confirmation, R2453	Exp. 08/20/2017

**4. PRODUCT DESCRIPTION:**

- 4.1 Asphalt Shingles:
- 4.1.1 Classic<sup>®</sup> and Supreme<sup>®</sup> are fiberglass reinforced, 3-tab asphalt roof shingles.
- 4.1.2 Berkshire<sup>®</sup> are fiberglass reinforced, 4-tab asphalt roof shingles.
- 4.1.3 Devonshire<sup>™</sup> are fiberglass reinforced, 5-tab asphalt roof shingles.
- 4.1.4 Duration<sup>®</sup>, TruDefinition<sup>®</sup> Duration<sup>®</sup>, Duration<sup>®</sup> Premium Cool, TruDefinition<sup>®</sup> Duration<sup>®</sup> Designer Color Collection, TruDefinition<sup>®</sup> Oakridge<sup>®</sup>, Oakridge<sup>®</sup> and WeatherGuard<sup>®</sup> HP are fiberglass reinforced, laminated asphalt roof shingles.
- 4.2 Berkshire<sup>®</sup> Hip & Ridge Shingles, High Ridge, Hip & Ridge with Sealant, WeatherGuard<sup>®</sup> HP Hip & Ridge Shingles, ProEdge Hip & Ridge Shingles and DuraRidge<sup>™</sup> Hip & Ridge Shingles are fiberglass reinforced, hip and ridge asphalt roof shingles.
- 4.3 Starter Strip Plus and Starter Shingle Roll are starter strips for asphalt roof shingles.

**5. LIMITATIONS:**

- 5.1 This is a building code evaluation. Neither Trinity|ERD nor Robert Nieminen, P.E. are, in any way, the Designer of Record for any project on which this Evaluation Report, or previous versions thereof, is/was used for permitting or design guidance unless retained specifically for that purpose.
- 5.2 This Evaluation Report is not for use in the HVHZ.
- 5.3 Fire Classification is not part of this Evaluation Report; refer to current Approved Roofing Materials Directory for fire ratings of this product.
- 5.4 Wind Classification:
- 5.4.1 All Owens Corning shingles noted herein are Classified in accordance with FBC Tables 1507.2.7.1 and R905.2.6.1 to ASTM D3161, Class F and/or ASTM D7158, Class H, indicating the shingles are acceptable for us in all wind zones up to V<sub>asd</sub> = 150 mph (V<sub>ult</sub> = 194 mph). Refer to Section 6 for installation requirements to meet this wind rating.
- 5.4.2 All Owens Corning hip & ridge shingles and Starter Strip Plus noted herein are Classified in accordance with FBC Tables 1507.2.7.1 and R905.2.6.1 to ASTM D3161, Class F, indicating the shingles are acceptable for us in all wind zones up to V<sub>asd</sub> = 150 mph (V<sub>ult</sub> = 194 mph). Refer to Section 6 for installation requirements to meet this wind rating.

- 5.4.3 Classification by ASTM D7158 applies to exposure category B or C and a building height of 60 feet or less. Calculations by a qualified design professional are required for conditions outside these limitations. Contact the shingle manufacturer for data specific to each shingle.
- 5.4.4 Refer to Owens Corning published information on wind resistance and installation limitations.
- 5.5 All products in the roof assembly shall have quality assurance audit in accordance with the Florida Building Code and F.A.C. Rule 61G20-3.

## 6. INSTALLATION:

### 6.1 Underlayment:

- 6.1.1 Underlayment shall be acceptable to Owens Corning and shall hold current Florida Statewide Product Approval, or be Locally Approved per Rule 61G20-3, per FBC Sections 1507.2.3, 1507.2.4 or R905.2.3.

### 6.2 Asphalt Shingles:

- 6.2.1 Installation of asphalt shingles shall comply with the manufacturer's current published instructions, using minimum four (4) nails per shingle in accordance with FBC Sections 1507.2 or R905.2, with the following exceptions:

- Berkshire® shingles require minimum five (5) nails per shingle.
- WeatherGuard® HP shingles require minimum six (6) nails per shingle.
- Devonshire™ shingles require minimum six (6) nails per shingle.
- Starter Strip Plus requires minimum five (5) nails per strip.

Refer to Owens Corning published information on wind resistance and installation limitations.

- 6.2.2 Fasteners shall be in accordance with the manufacturer's published requirements, but not less than FBC 1507.2.6 or R905.2.5. Staples are not permitted.

- 6.2.4 Where the roof slope exceeds 2:1 units vertical in 12 units horizontal, special methods of fastening are required. Contact the shingle manufacturer for details.

- 6.2.5 Minimum Nailing – Classic® & Supreme:

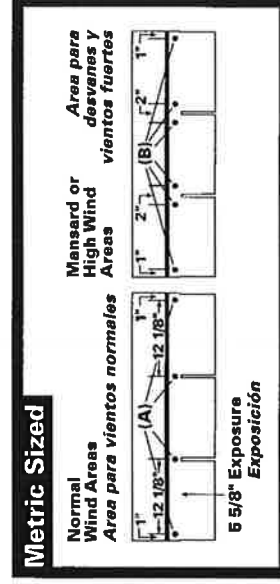
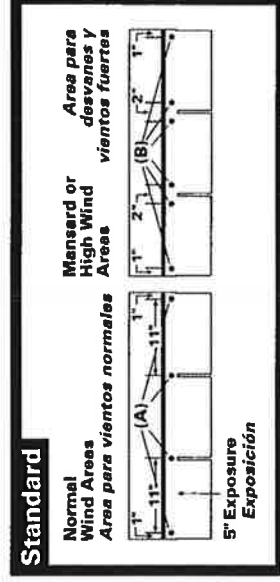

- 6.2.6 Minimum Nailing – Berkshire®:

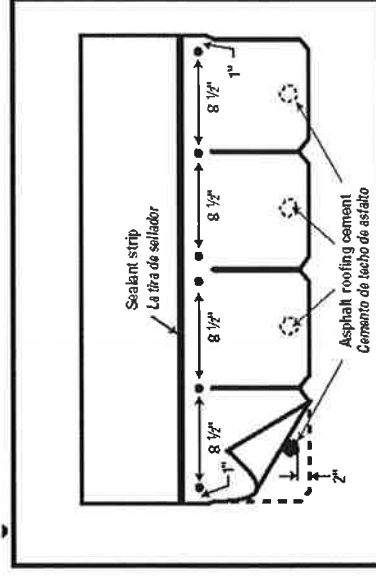
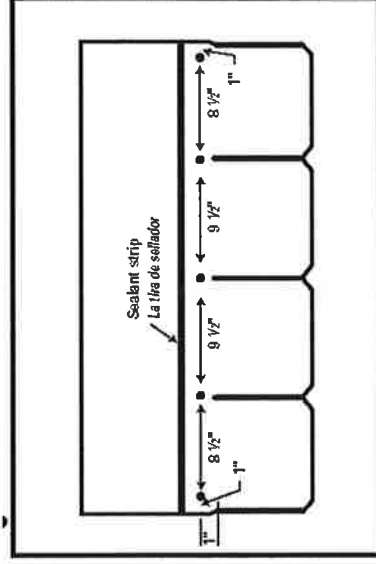

6.2.7 Minimum Nailing – Devonshire™;

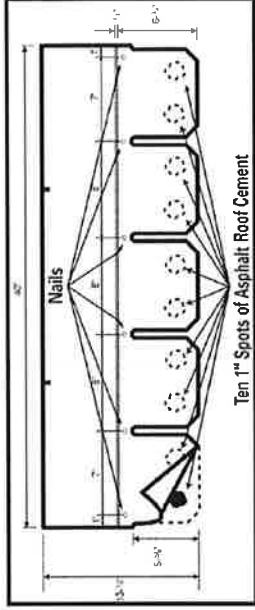
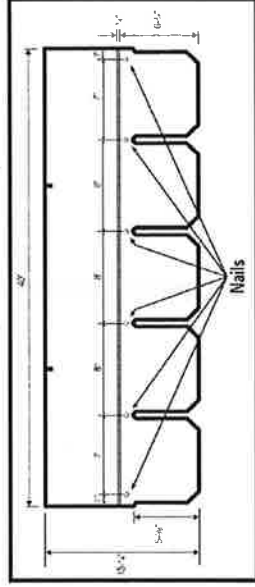

6.2.8 Minimum Nailing – Duration®, TruDefinition® Duration, Duration® Premium Cool & TruDefinition® Duration Designer Color Collection:

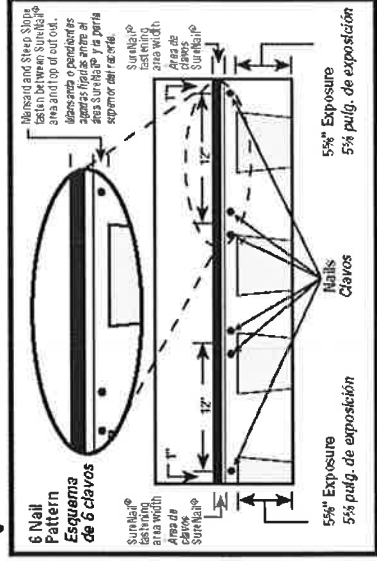
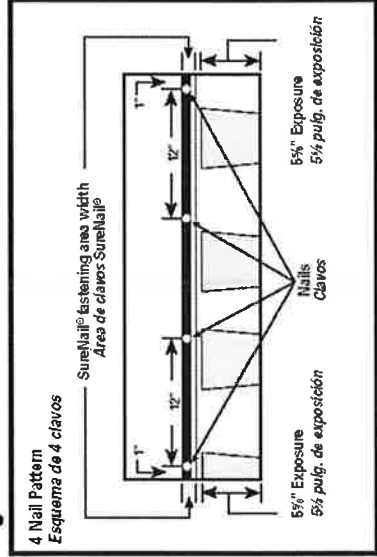

6.2.9 Minimum Nailing – TruDefinition® Oakridge®, Oakridge®:

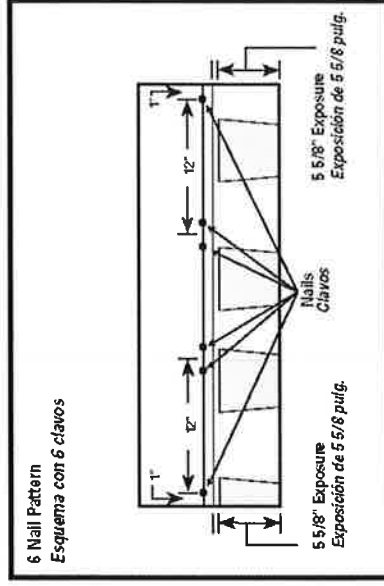
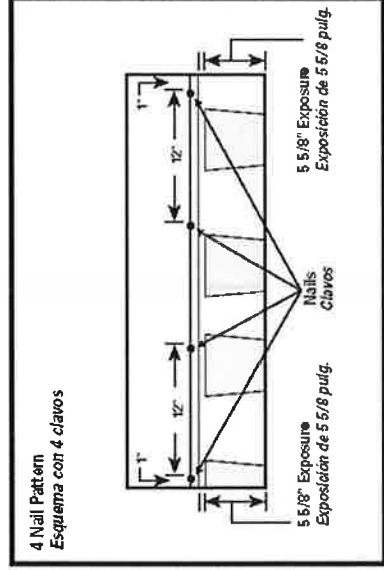

6.2.10 Minimum Nailing – WeatherGuard® HP:

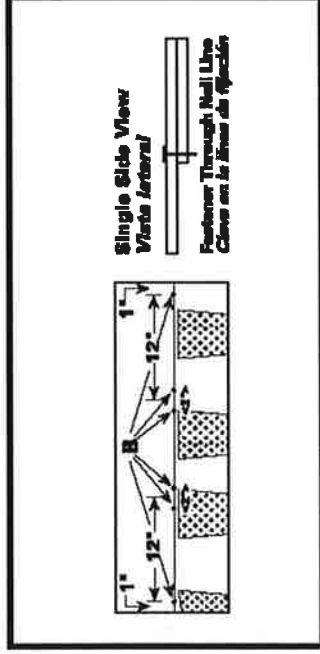

**6.3 Hip & Ridge Shingles:**

6.3.1 Installation of Berkshire® Hip and Ridge Shingles, High Ridge, Hip & Ridge with Sealant, WeatherGuard® HP Hip and Ridge Shingles and ProEdge Hip & Ridge Shingles shall comply with the manufacturer's current published instructions, using four (4) nails per shingle. Installation of DuraRidge™ Hip & Ridge Shingles shall comply with the manufacturer's current published instructions, using two (2) nails per shingle. Refer to Owens Corning published information on wind resistance and installation limitations, including the use of hand-sealing for wind warranties.

6.3.2 Fasteners shall be in accordance with the manufacturer's published requirements, but not less than FBC 1507.2.6 or R905.2.5. Staples are not permitted.

6.3.3 Minimum Nailing – Berkshire® Hip & Ridge and High Ridge:

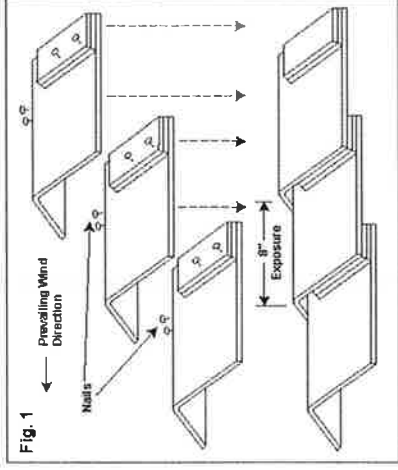

Fig. 1

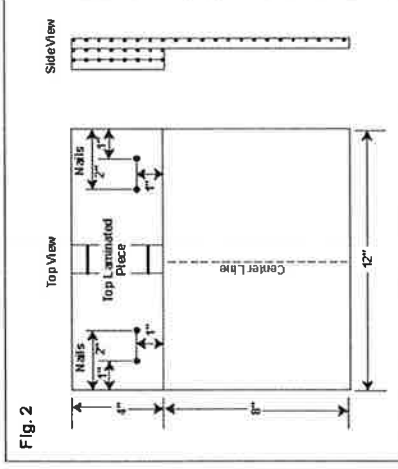
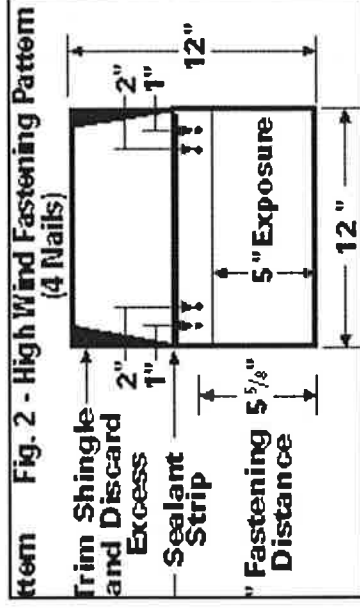

Fig. 2

6.3.4 Minimum Nailing – Hip & Ridge with Sealant:



6.3.5 Minimum Nailing – WeatherGuard® HP Hip and Ridge:

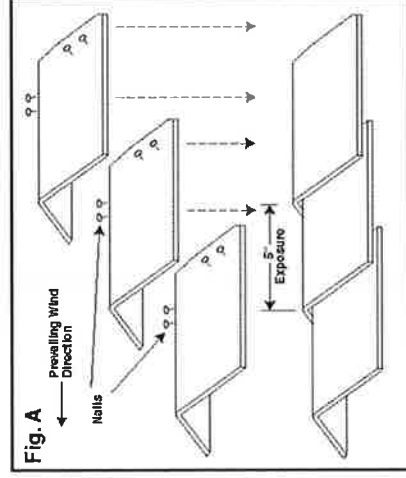

Fig. A

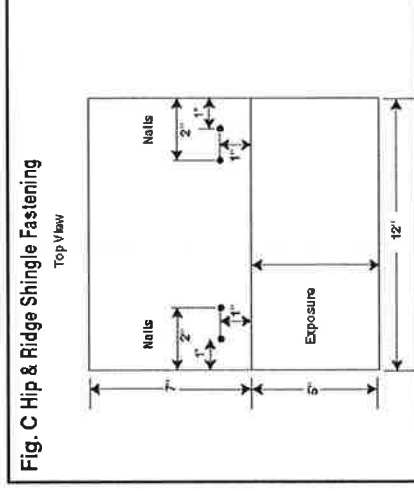
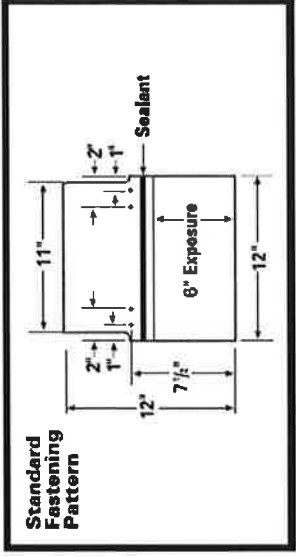
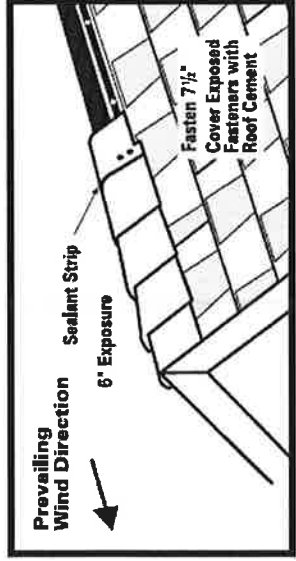

Fig. C Hip & Ridge Shingle Fastening

6.3.6 Minimum Nailing - ProEdge Hip & Ridge Shingles:



6.3.7 Minimum Nailing – DuraRidge™ Hip & Ridge Shingles:

Note: The drawings below pertain to minimum, as-tested attachment requirements. Refer to Owens Corning published installation instructions for their minimum requirements.

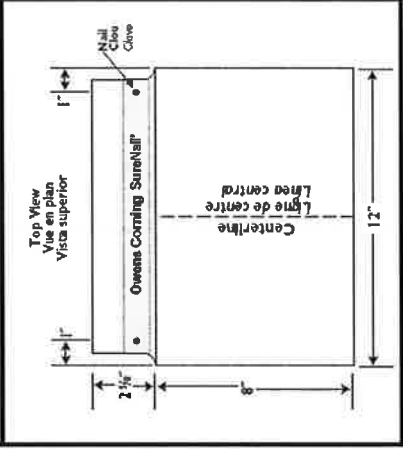
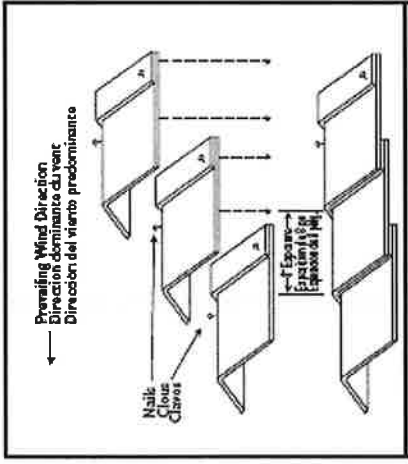

7. LABELING:

- 7.1 Labeling shall be in accordance with the requirements the Accredited Quality Assurance Agency noted herein.
- 7.2 Asphalt shingle wrappers shall indicate compliance with one of the required classifications detailed in FBC Table 1507.2.7.1 / R905.2.6.1.

8. BUILDING PERMIT REQUIREMENTS:

As required by the Building Official or Authority Having Jurisdiction in order to properly evaluate the installation of this product.

9. MANUFACTURING PLANTS:

Contact the named QA entity for information on which plants produce products covered by Florida Rule 9N-3 QA requirements.

10. QUALITY ASSURANCE ENTITY:

UL LLC- QUA9625 ; (414) 248-6409; [karen.buchmann@ul.com](mailto:karen.buchmann@ul.com)

- END OF EVALUATION REPORT -



**Product Approval**  
 USER: Public User



[Product Approval Menu](#) > [Product or Application Search](#) > [Application List](#) > **Application Detail**

FL # FL12328-R5  
 Application Type Revision  
 Code Version 2014  
 Application Status Approved

Comments  
 Archived

Product Manufacturer  
 Address/Phone/Email  
 TAMKO Building Products, Inc.  
 PO Box 1404  
 Joplin, MO 64802  
 (417) 624-6644 Ext 2305  
 kerri\_eden@tamko.com

Authorized Signature  
 Kerri Eden  
 kerri\_eden@tamko.com

Technical Representative  
 Address/Phone/Email  
 Kerri Eden  
 PO Box 1404  
 Joplin, MO 64802  
 (417) 624-6644 Ext 2305  
 kerri\_eden@tamko.com

Quality Assurance Representative  
 Address/Phone/Email

Category  
 Subcategory  
 Roofing  
 Underlayments

Compliance Method  
 Evaluation Report from a Florida Registered Architect or a Licensed Professional Engineer  
 ✓ Evaluation Report - Hardcopy Received

Florida Engineer or Architect Name who developed the Evaluation Report Zachary R. Priest  
 Florida License PE-74021  
 Quality Assurance Entity UL LLC  
 Quality Assurance Contract Expiration Date 02/26/2016  
 Validated By Locke Bowden  
 ✓ Validation Checklist - Hardcopy Received

Certificate of Independence [FL12328\\_R5\\_COI\\_IBP14001\\_2010\\_FPA\\_TAMKO\\_Underlayments](#)

Referenced Standard and Year (of Standard)  
**Standard**  
 ASTM D1970  
 ASTM D226  
 ASTM D4869  
 ASTM D6380  
**Year**  
 2009  
 2006  
 2005  
 2003

Equivalence of Product Standards  
 Certified By

Sections from the Code

Product Approval Method

Method 1 Option D

Date Submitted

04/13/2015

Date Validated

04/15/2015

Date Pending FBC Approval

04/22/2015

Date Approved

06/22/2015

**Summary of Products**

FL #	Model, Number or Name	Description
12328.1	ASTM Slate Surfaced Roll Roofing	Roll roofing surfaced with mineral granules
<p><b>Limits of Use</b>                      Approved for use in HVHZ: No                      Approved for use outside HVHZ: Yes                      Impact Resistant: N/A                      Design Pressure: N/A                      Other: See evaluation report for limits of use.</p>		
12328.2	ASTM Tile Underlayment	Coated organic underlayment
<p><b>Limits of Use</b>                      Approved for use in HVHZ: No                      Approved for use outside HVHZ: Yes                      Impact Resistant: N/A                      Design Pressure: N/A                      Other: See evaluation report for limits of use.</p>		
12328.3	Master Smooth	Asphalt saturated organic underlayment.
<p><b>Limits of Use</b>                      Approved for use in HVHZ: No                      Approved for use outside HVHZ: Yes                      Impact Resistant: N/A                      Design Pressure: N/A                      Other: See evaluation report for limits of use.</p>		
12328.4	Moisture Guard Plus	A self-adhering modified bitumen underlayment.
<p><b>Limits of Use</b>                      Approved for use in HVHZ: No                      Approved for use outside HVHZ: Yes                      Impact Resistant: N/A                      Design Pressure: N/A                      Other: See evaluation report for limits of use.</p>		
12328.5	No. 15 ASTM	Asphalt saturated organic felt
<p><b>Limits of Use</b>                      Approved for use in HVHZ: No                      Approved for use outside HVHZ: Yes                      Impact Resistant: N/A                      Design Pressure: N/A                      Other: See evaluation report for limits of use.</p>		
12328.6	No. 15 UL	Asphalt saturated organic felt

<p><b>Limits of Use</b>  <b>Approved for use in HVHZ:</b> No  <b>Approved for use outside HVHZ:</b> Yes  <b>Impact Resistant:</b> N/A  <b>Design Pressure:</b> N/A  <b>Other:</b> See evaluation report for limits of use.</p>	<p><b>Installation Instructions</b>  <a href="#">FL12328_R5_II_TBP14001_1_2014_FPA_TAMKO Underlayments.pdf</a>                  Verified By: Zachary R. Priest 74021                  Created by Independent Third Party: Yes  <b>Evaluation Reports</b>  <a href="#">FL12328_R5_AE_TBP14001_1_2014_FPA_TAMKO Underlayments.pdf</a>                  Created by Independent Third Party: Yes</p>
<p>12328.7                  No. 30 ASTM</p> <p><b>Limits of Use</b>  <b>Approved for use in HVHZ:</b> No  <b>Approved for use outside HVHZ:</b> Yes  <b>Impact Resistant:</b> N/A  <b>Design Pressure:</b> N/A  <b>Other:</b> See evaluation report for limits of use.</p>	<p>Asphalt saturated organic felt</p> <p><b>Installation Instructions</b>  <a href="#">FL12328_R5_II_TBP14001_1_2014_FPA_TAMKO Underlayments.pdf</a>                  Verified By: Zachary R. Priest 74021                  Created by Independent Third Party: Yes  <b>Evaluation Reports</b>  <a href="#">FL12328_R5_AE_TBP14001_1_2014_FPA_TAMKO Underlayments.pdf</a>                  Created by Independent Third Party: Yes</p>
<p>12328.8                  No. 30 UL</p> <p><b>Limits of Use</b>  <b>Approved for use in HVHZ:</b> No  <b>Approved for use outside HVHZ:</b> Yes  <b>Impact Resistant:</b> N/A  <b>Design Pressure:</b> N/A  <b>Other:</b> See evaluation report for limits of use.</p>	<p>Asphalt saturated organic felt</p> <p><b>Installation Instructions</b>  <a href="#">FL12328_R5_II_TBP14001_1_2014_FPA_TAMKO Underlayments.pdf</a>                  Verified By: Zachary R. Priest 74021                  Created by Independent Third Party: Yes  <b>Evaluation Reports</b>  <a href="#">FL12328_R5_AE_TBP14001_1_2014_FPA_TAMKO Underlayments.pdf</a>                  Created by Independent Third Party: Yes</p>
<p>12328.9                  TW Metal and Tile Underlayment</p> <p><b>Limits of Use</b>  <b>Approved for use in HVHZ:</b> No  <b>Approved for use outside HVHZ:</b> Yes  <b>Impact Resistant:</b> N/A  <b>Design Pressure:</b> N/A  <b>Other:</b> See evaluation report for limits of use.</p>	<p>self-adhering modified bitumen underlayment</p> <p><b>Installation Instructions</b>  <a href="#">FL12328_R5_II_TBP14001_1_2014_FPA_TAMKO Underlayments.pdf</a>                  Verified By: Zachary R. Priest 74021                  Created by Independent Third Party: Yes  <b>Evaluation Reports</b>  <a href="#">FL12328_R5_AE_TBP14001_1_2014_FPA_TAMKO Underlayments.pdf</a>                  Created by Independent Third Party: Yes</p>
<p>12328.10                  TW Underlayment</p> <p><b>Limits of Use</b>  <b>Approved for use in HVHZ:</b> No  <b>Approved for use outside HVHZ:</b> Yes  <b>Impact Resistant:</b> N/A  <b>Design Pressure:</b> N/A  <b>Other:</b> See evaluation report for limits of use.</p>	<p>self-adhering modified bitumen underlayment</p> <p><b>Installation Instructions</b>  <a href="#">FL12328_R5_II_TBP14001_1_2014_FPA_TAMKO Underlayments.pdf</a>                  Verified By: Zachary R. Priest 74021                  Created by Independent Third Party: Yes  <b>Evaluation Reports</b>  <a href="#">FL12328_R5_AE_TBP14001_1_2014_FPA_TAMKO Underlayments.pdf</a>                  Created by Independent Third Party: Yes</p>

[Back](#) [Next](#)

Contact Us :: 1940 North Monroe Street, Tallahassee FL 32399 Phone: 850-487-1824

The State of Florida is an AA/EEO employer. Copyright 2007-2013 State of Florida. :: Privacy Statement :: Accessibility Statement :: Refund Under Florida law, email addresses are public records. If you do not want your e-mail address released in response to a public-records request, please contact the office by phone or by traditional mail. If you have any questions, please contact 850.487.1355 Section 455.275(1), Florida Statutes, effective October 1, 2012, licensees licensed under Chapter 455, F.S. must provide the Department with an email address for official communication with the licensee. However email addresses are public records. If you do not wish to supply a personal address, please provide the Department with an email address which can be made available to the public. To de-identify an email address, please contact the Department at 850.487.1355. If you are a licensee under Chapter 455, F.S., please click [here](#).

Product Approval Accepts:





# CREEK TECHNICAL SERVICES, LLC

Certificate of Authorization No. 29824  
17520 Edinburgh Drive  
Tampa, FL 33647  
(813) 480-3421

## EVALUATION REPORT

2014 FLORIDA BUILDING CODE

### Manufacturer:

TAMKO BUILDING PRODUCTS, INC.  
P.O. Box 1404  
Joplin, MO 64802  
(417) 624-6644  
<http://www.tamko.com>

Issued April 13, 2015

### Quality Assurance:

UL LLC (QUA9625)

## SCOPE

### Category:

Roofing

### Subcategory:

Underlayments

### Code Sections:

1507.2.3, 1507.2.4, 1507.2.8, 1507.2.9.2, 1507.3.3, 1507.4.5.1, 1507.4.5.2, 1507.4.5.3,  
1507.5.3, 1507.5.3.2, 1507.6.3, 1507.6.3.2, 1507.6.5, 1507.7.3, 1507.7.3.2, 1507.8.3,  
1507.8.3.2, 1507.8.8, T1507.8, 1507.9.3, 1507.9.3.2, 1507.9.5, 1507.9.9

### Properties:

Physical properties

## REFERENCES

Entity	Report No.	Standard	Year
PRI Construction Materials Technologies (TST6049)	TAP-191-02-01REV	ASTM D 1970	2009
PRI Construction Materials Technologies (TST6049)	TAP-192-02-01	ASTM D 1970	2009
PRI Construction Materials Technologies (TST6049)	TAP-193-02-01	ASTM D 1970	2009
PRI Construction Materials Technologies (TST6049)	TAP-214-02-01	ASTM D 4869	2005e01
PRI Construction Materials Technologies (TST6049)	TAP-215-02-01	ASTM D 226	2006
PRI Construction Materials Technologies (TST6049)	TAP-216-02-03	ASTM D 6380	2003(2009)
PRI Construction Materials Technologies (TST6049)	TAP-217-02-01REV	ASTM D 6380	2003(2009)
PRI Construction Materials Technologies (TST6049)	TAP-218-02-01	ASTM D 226	2006
PRI Construction Materials Technologies (TST6049)	TAP-219-02-01	ASTM D 226	2006
PRI Construction Materials Technologies (TST6049)	TAP-220-02-01	ASTM D 6380	2003(2009)
PRI Construction Materials Technologies (TST6049)	TAP-222-02-01	ASTM D 4869	2005e01
UL LLC (TST9628)	13CA12Z69	ASTM D 226	2006

## PRODUCT DESCRIPTION AND APPLICATION

### TAMKO® ASTM Slate Surfaced Roll Roofing

ASTM D 6380, Class M, Type II underlayment constructed from organic felt saturated with asphalt and coated on both sides with asphalt and surfaced with granules.

Min. slope:

2:12

Application:

The underlayment shall be installed with minimum 2" side laps and minimum 4" staggered end laps and in accordance with FRSA/TRI 07230 for tile applications.

Allowable roof coverings:

Attachment of asphalt shingle valleys and clay and concrete tile shall be permitted in accordance with the FBC.

TBP14001.1

FL12328-R5

Page 1 of 4

This evaluation report is provided for State of Florida product approval under Rule 61G20-3. The manufacturer shall notify CREEK Technical Services, LLC of any product changes or quality assurance changes throughout the duration for which this report is valid. This evaluation report does not express nor imply warranty, installation, recommended use, or other product attributes that are not specifically addressed herein.



**TAMKO® ASTM Tile Underlayment**

ASTM D 6380, Class M, Type II underlayment constructed from an organic felt saturated with asphalt then coated on both sides with asphalt and surfaced with granules.

**Application:**

The underlayment shall be installed with minimum 2" side laps and minimum 4" staggered end laps and in accordance with FRSA/TRI 07230 for tile applications.

**Allowable roof coverings:**

Attachment of clay and concrete tile shall be permitted in accordance with the FBC.

**TAMKO® Master Smooth**

ASTM D 6380, Class S, Type IV underlayment constructed from an organic felt saturated with asphalt then coated on both sides with asphalt and surfaced with a fine mineral.

**Application:**

The underlayment shall be installed along the valley in accordance with FBC requirements.

**Allowable roof coverings:**

Attachment of asphalt shingle valleys shall be permitted in accordance with the FBC.

**TAMKO® Moisture Guard Plus®**

Self-adhered, ASTM D 1970, fiberglass reinforced, modified bitumen sheet membrane with a mineral surfacing and a removable release film on the adhesive side.

**Application:**

The underlayment shall be attached by adhering directly to the roof deck with minimum 3-1/2" side laps and minimum 6" staggered end laps.

**Min. application temperature:**

40°F.

**Allowable roof coverings:**

Attachment of asphalt shingles and mechanically fastened concrete and clay tile roofing shall be permitted in accordance with the FBC.

**TAMKO® No. 15 ASTM Asphalt Saturated Organic Felt**

ASTM D 226, Type I underlayment constructed from a non-perforated organic felt that is saturated with asphalt.

**Application:**

The underlayment shall be installed with minimum 2" side laps and minimum 4" end laps.

**Allowable roof coverings:**

Attachment of asphalt shingles, metal roofing, wood shingles, wood shakes, and roll roofing shall be permitted in accordance with the FBC.

**TAMKO® No. 15 UL Asphalt Saturated Organic Felt**

ASTM D 226, Type I underlayment constructed from a non-perforated organic felt that is saturated with asphalt.

**Application:**

The underlayment shall be installed with minimum 2" side laps and minimum 4" end laps.

**Allowable roof coverings:**

Attachment of asphalt shingles, metal roofing, wood shingles, wood shakes, and roll roofing shall be permitted in accordance with the FBC.



**TAMKO® No. 30 ASTM  
Asphalt Saturated  
Organic Felt**

ASTM D 226, Type II underlayment constructed from a non-perforated organic felt that is saturated with asphalt.

**Application:**

The underlayment shall be installed with minimum 2" side laps and minimum 4" end laps.

**Allowable roof coverings:**

Attachment of asphalt shingles, metal roofing, clay and concrete tile, slate shingles, wood shingles, wood shakes, and roll roofing shall be permitted in accordance with the FBC.

**TAMKO® No. 30 UL  
Asphalt Saturated  
Organic Felt**

ASTM D 226, Type II underlayment constructed from a non-perforated organic felt that is saturated with asphalt.

**Application:**

The underlayment shall be installed with minimum 2" side laps and minimum 4" end laps.

**Allowable roof coverings:**

Attachment of asphalt shingles, metal roofing, clay and concrete tile, slate shingles, wood shingles, wood shakes, and roll roofing shall be permitted in accordance with the FBC.

**TAMKO® TW Metal and  
Tile Underlayment**

Self-adhered, flexible, ASTM D 1970, rubberized asphalt sheet membrane with a polymer film on the surface and a removable release film on the adhesive side.

**Application:**

The underlayment shall be attached by adhering directly to the roof deck with minimum 4" side laps and minimum 6" staggered end laps.

**Min. application temperature:**

40°F

**Allowable roof coverings:**

Attachment of asphalt shingles, metal roofing, and mechanically fastened clay and concrete tiles shall be permitted in accordance with the FBC.

**TAMKO® TW  
Underlayment**

Self-adhered, flexible, ASTM D 1970, rubberized asphalt sheet membrane with a polymer film on the surface and a removable release film on the adhesive side.

**Application:**

The underlayment shall be attached by adhering directly to the roof deck with minimum 4" side laps and minimum 6" staggered end laps.

**Min. application temperature:**

40°F

**Allowable roof coverings:**

Attachment of asphalt shingles and metal roofing shall be permitted in accordance with the FBC.

**LIMITATIONS**

- 1) This evaluation report is not for use in the HVHZ.
- 2) Fire Classification is not within the scope of this evaluation.
- 3) Wind uplift resistance is not within scope of this evaluation.
- 4) Installation of the evaluated product shall comply with this report, the FBC, and the manufacturer's published application instructions. Where discrepancies exist between these sources, the more restrictive and FBC compliant installation detail shall prevail.
- 5) Minimum application temperature shall be 50°F unless otherwise noted. Contact the manufacturer when installing at temperatures below the minimum application temperature.
- 6) Deck substrates shall be clean, dry, and free from any irregularities and debris. All fasteners in the deck shall be checked for protrusion and corrected prior to underlayment application.
- 7) The roof deck shall be constructed of closely fitted sheathing for new or existing construction. Roof deck shall be installed in accordance with FBC requirements.
- 8) Unless otherwise stated, the minimum roof slope shall be in accordance with FBC requirements.
- 9) All underlayments shall be installed with the roll length parallel to the eave, starting at the eave, and lapped in successive courses installed up the deck in a manner that effectively sheds water from the deck. End laps shall be staggered between courses in accordance with the manufacturer's application instructions.
- 10) The underlayment may be used as described in other current FBC product approval documents.
- 11) The underlayment shall not be installed over existing roof coverings.
- 12) Contact the manufacturer regarding specific exposure limits for each underlayment.
- 13) All products listed in this report shall be manufactured under a quality assurance program in compliance with Rule 61G20-3.

**COMPLIANCE STATEMENT**

The products evaluated herein by Zachary R. Priest, P.E. have demonstrated compliance with the 2014 Florida Building Code as evidenced in the referenced documents submitted by the named manufacturer.



2015.04.1  
3 09:06:05  
-04'00'

*Zachary R. Priest*  
Professional Engineer

Zachary R. Priest, P.E.  
Florida Registration No. 74021  
Organization No. ANE9641

**CERTIFICATION OF INDEPENDENCE**

CREEK Technical Services, LLC does not have, nor will it acquire, a financial interest in any company manufacturing or distributing products under this evaluation.

CREEK Technical Services, LLC is not owned, operated, or controlled by any company manufacturing or distributing products under this evaluation.

Zachary R. Priest, P.E. does not have, nor will acquire, a financial interest in any company manufacturing or distributing products under this evaluation.

Zachary R. Priest, P.E. does not have, nor will acquire, a financial interest in any other entity involved in the approval process of the product.

**END OF REPORT**

TBP14001.1

FL12328-R5

Page 4 of 4

This evaluation report is provided for State of Florida product approval under Rule 61G20-3. The manufacturer shall notify CREEK Technical Services, LLC of any product changes or quality assurance changes throughout the duration for which this report is valid. This evaluation report does not express nor imply warranty, installation, recommended use, or other product attributes that are not specifically addressed herein.

2014  
EXPIRES SEPTEMBER 30, 2014

**PATSY HEFFNER, TAX COLLECTOR**  
OSCEOLA COUNTY, STATE OF FLORIDA  
LOCAL BUSINESS TAX RECEIPT

ACCOUNT NO.  
92917

BUSINESS TYPE  
BUSINESS 6420 ROOFING CONTR (DBPR/CHPCRD)

E & V Roofing Company, Inc.  
119 Honeywood Dr.  
Kissimmee, FL 34743

RENEWAL	0.00
NEW LICENSE	30.00
TRANSFER	0.00
ORIGINAL TAX	
AMOUNT	
PENALTY	0.00
COLLECTION COST	0.00
TOTAL	30.00

PATSY HEFFNER	
Tax Collector	
6420-92917	
1301400	
10/01/2013	
Oper	YM
Thru	25
Paid	30.00

OSCEOLA COUNTY  
E & V Roofing Company, Inc.  
119 Honeywood Dr.  
Kissimmee, FL 34743

*Patsy Heffner*

PATSY HEFFNER, TAX COLLECTOR  
P.O. BOX 422105, KISSIMMEE FL 34742-2105  
407-742-4000

Q845842/CCC1327124

<p><b>STATE OF FLORIDA</b> DEPARTMENT OF FINANCIAL SERVICES DIVISION OF WORKERS' COMPENSATION CONSTRUCTION INDUSTRY EXEMPTION</p> <p><small>CONTRACTORS OF SUBJECT TO AN EXEMPTION FROM FLORIDA WORKERS' COMPENSATION LAW</small></p> <p>EXPIRES DATE: 4/15/214      EXPIRATION DATE: 4/15/214          LICENSE: C072      NUMBER: 877000          TYPE: 2000000</p> <p>BUSINESS NAME AND ADDRESS:          E &amp; V ROOFING COMPANY INC          119 HONEYWOOD DR      FL      34743          KISSIMMEE</p> <p>SCOPE OF BUSINESS OR TRADE:          LICENSED ROOFING CONTRACTOR</p>	<p><b>F O L D      H E R E</b></p> <p><b>IMPORTANT</b>          Pursuant to Chapter 400.001(1), Florida Statutes, any contractor or subcontractor who is not a contractor or subcontractor under this section may not receive benefits or compensation under the statute.          Pursuant to Chapter 400.001(2), Florida Statutes, the contractor or subcontractor is required to file a copy of the business or trade license on the office of Section to the contract.          Pursuant to Chapter 400.001(3), Florida Statutes, notices of election to be insured and certificates of election to be insured, all the contractor or subcontractor must file with the contractor or subcontractor at the time of the contract. The contractor or subcontractor is required to file a copy of the contract with the contractor or subcontractor. The contractor or subcontractor is required to file a copy of the contract with the contractor or subcontractor.</p>
---	---

**STATE OF FLORIDA**  
DEPARTMENT OF BUSINESS AND PROFESSIONAL REGULATION

CCC1327124      ISSUED: 07/15/2014

CERTIFIED ROOFING CONTRACTOR  
 ORTIZ, REFUGIO  
 E & V ROOFING COMPANY INC

IS CERTIFIED under the provisions of Ch. 489 F.S.  
 Expiration date : AUG 31, 2016      L140715000081

**JEFF ATWATER, CHIEF FINANCIAL OFFICER**  
 FLORIDA DEPARTMENT OF FINANCIAL SERVICES



WC Home    WC Databases    CFO Home

**Exemption Detail Page**

This database was last updated Wednesday, March 11, 2015 12:10 AM.

[Return to Previous Page](#)

**Exemption Details**

Name	Title	Effective Date	Termination Date	Exemption Type	**Business Activities	Employer Name
REFUGIO ORTIZ	PR	Apr 18 2014	Apr 17 2016	Construction	<a href="#">Click Here to View Activities Listed on Exemption</a>	E & V ROOFING COMPANY INC
REFUGIO ORTIZ	PR	Apr 18 2012	Apr 18 2014	Construction	<a href="#">Click Here to View Activities Listed on Exemption</a>	E & V ROOFING COMPANY INC
REFUGIO ORTIZ	PR	May 10 2010	Apr 18 2012	Construction	<a href="#">Click Here to View Activities Listed on Exemption</a>	E & V ROOFING COMPANY INC
REFUGIO ORTIZ	PR	Apr 10 2008	Apr 10 2010	Construction	<a href="#">Click Here to View Activities Listed on Exemption</a>	E & V ROOFING COMPANY INC
REFUGIO ORTIZ	PR	Mar 8 2006	Mar 7 2008	Construction	<a href="#">Click Here to View Activities Listed on Exemption</a>	E & V ROOFING COMPANY INC

\*Termination may be through the revocation of the exemption, or expiration of the exemption.  
 \*\*The exemption only applies to the business activities listed on the exemption.

[Return to Search Page](#)

2015 BTR.pdf label-e-v-roofing Open

- Gmail Remove label
- COMPOSE
- ESP.N.com - Pistons Handle Mav...
- Inbox (92) Remove label
- License Inbox x E&V Roofi
- Starred
- Sent Mail
- Drafts (52)
- E & V Roofing Company
- Katrina, Attach is the busir
- Categories
- Katrina Gutierrez
- Attached the items to upd
- Social (8)
- Katrina Gutierrez
- Promotions (1)
- Katrina Gutierrez <uniqu
- to rstewart
- Updates (30)
- Forwarded mess
- From: E & V Roofing Co
- Date: Thu, Sep 11, 2014
- Subject: License
- To: Katrina Gutierrez <uniqu
- From: Katrina

Enabling "last seen" lets your contacts see you're online. [Learn more](#)

Re-enable

Hello,  
Attached is the info need

BUSINESS TYPE BUSINESS 6420 ROOFING CONTR (DBPR/CHPCRD)  
 BUSINESS E & V Roofing Company, Inc.  
 119 Honeywood Dr.  
 Kissimmee, FL 34743

MAILING ADDRESS OSCEOLA COUNTY  
 E & V Roofing Company, Inc.  
 119 Honeywood Dr.  
 Kissimmee, FL 34743

2015  
 EXPIRES SEPTEMBER 30, 2015  
 PATSY HEFFNER, TAX COLLECTOR  
 OSCEOLA COUNTY, STATE OF FLORIDA  
 LOCAL BUSINESS TAX RECEIPT

RENEWAL NEW LICENSE TRANSFER ORIGINAL TAX AMOUNT  
 PENALTY COLLECTION COST TOTAL

PATSY HEFFNER  
 Tax Collector  
 6420-92917  
 010896  
 18/01/2014  
 Oper N/A  
 Till Intern  
 Paid 33.00

ACCOUNT NO. 92917

*Patsy Heffner*

PATSY HEFFNER, TAX COLLECTOR  
 P.O. BOX 422105, KISSIMMEE FL 34742-4000

2015 BTR.pdf

Scanned by CamScanner

<https://mail.google.com/mail/u/0/?tab=wm>

1/8/2015



# CERTIFICATE OF LIABILITY INSURANCE

DATE (MM/DD/YYYY)  
08/11/2015

THIS CERTIFICATE IS ISSUED AS A MATTER OF INFORMATION ONLY AND CONFERS NO RIGHTS UPON THE CERTIFICATE HOLDER. THIS CERTIFICATE DOES NOT AFFIRMATIVELY OR NEGATIVELY AMEND, EXTEND OR ALTER THE COVERAGE AFFORDED BY THE POLICIES BELOW. THIS CERTIFICATE OF INSURANCE DOES NOT CONSTITUTE A CONTRACT BETWEEN THE ISSUING INSURER(S), AUTHORIZED REPRESENTATIVE OR PRODUCER, AND THE CERTIFICATE HOLDER.

**IMPORTANT:** If the certificate holder is an ADDITIONAL INSURED, the policy(ies) must be endorsed. If SUBROGATION IS WAIVED, subject to the terms and conditions of the policy, certain policies may require an endorsement. A statement on this certificate does not confer rights to the certificate holder in lieu of such endorsement(s).

PRODUCER	Enterprise Insurance Group, LLC 12320 Racetrack Road Tampa, FL 33626 License #: L059361	CONTACT NAME: Casey Lovelace PHONE (A/C, No. Ext): (813)448-9222 E-MAIL ADDRESS: service@enterpriseinsgroup.com	FAX (A/C, No): (813)448-9244
INSURED	E and V Roofing Company Inc 119 Honeywood Drive Kissimmee, FL 34743	INSURER(S) AFFORDING COVERAGE INSURER A: Amtrust International Underwriters INSURER B: INSURER C: INSURER D: INSURER E: INSURER F:	

COVERAGES      CERTIFICATE NUMBER: 00006017-216633      POLICY NUMBER: 2      REVISION NUMBER: 2

THIS IS TO CERTIFY THAT THE POLICIES OF INSURANCE LISTED BELOW HAVE BEEN ISSUED TO THE INSURED NAMED ABOVE FOR THE POLICY PERIOD INDICATED. NOTWITHSTANDING ANY REQUIREMENT, TERM OR CONDITION OF ANY CONTRACT OR OTHER DOCUMENT WITH RESPECT TO WHICH THIS CERTIFICATE MAY BE ISSUED OR MAY PERTAIN, THE INSURANCE AFFORDED BY THE POLICIES DESCRIBED HEREIN IS SUBJECT TO ALL THE TERMS, EXCLUSIONS AND CONDITIONS OF SUCH POLICIES. LIMITS SHOWN MAY HAVE BEEN REDUCED BY PAID CLAIMS.

INSR LTR	TYPE OF INSURANCE	ADDITIONAL SUBROGATION RIGHTS	POLICY NUMBER	POLICY EFF. DATE	POLICY EXPIRATION DATE	LIMITS
A	GENERAL LIABILITY <input checked="" type="checkbox"/> COMMERCIAL GENERAL LIABILITY CLAIMS-MADE <input checked="" type="checkbox"/> OCCUR		DSI 1045921 01	05/13/2015	05/13/2016	EACH OCCURRENCE \$ 1,000,000 DAMAGE TO RENTED PREMISES (Per occurrence) \$ 50,000 MED EXP (Any one person) \$ 5,000 PERSONAL & ADV INJURY \$ 1,000,000 GENERAL AGGREGATE \$ 2,000,000 PRODUCTS - COMPI/OP AGG \$ 1,000,000
	GEN'L AGGREGATE LIMIT, APPLIES PER POLICY PROJECT LOC					
	AUTOMOBILE LIABILITY					
	ANY AUTO					
	ALL OWNED AUTOS					
	HIRE AUTOS					
	SCHEDULED AUTOS					
	NON-OWNED AUTOS					
	UMBRELLA LIAB					
	EXCESS LIAB					
	DED RETENTION \$					
	WORKERS COMPENSATION AND EMPLOYERS' LIABILITY					
	ANY PROPRIETOR/PARTNER/EXECUTIVE OFFICER/MEMBER EXCLUDED? (Mandatory in NH)	Y/N				
	If yes, describe under DESCRIPTION OF OPERATIONS below	N/A				

DESCRIPTION OF OPERATIONS / LOCATIONS / VEHICLES (Attach ACORD 101, Additional Remarks Schedule, if more space is required)  
**Certificate is for Evidence of Insurance Only**

CERTIFICATE HOLDER	City of Belle Isle 1600 Nela Avenue Belle Isle, FL 32809
CANCELLATION	SHOULD ANY OF THE ABOVE DESCRIBED POLICIES BE CANCELLED BEFORE THE EXPIRATION DATE THEREOF, NOTICE WILL BE DELIVERED IN ACCORDANCE WITH THE POLICY PROVISIONS.  AUTHORIZED REPRESENTATIVE

ACORD 25 (2010/05)      © 1988-2010 ACORD CORPORATION. All rights reserved.      The ACORD name and logo are registered marks of ACORD      Printed by CLL on August 11, 2015 at 11:22AM